

# DXP, DXP Plus, FXS, and FXT Digital Communications System

## Non-LCD Speakerphone Station User's Guide

This publication supports both  
Impact and Impact SCS LCD Speakerphones

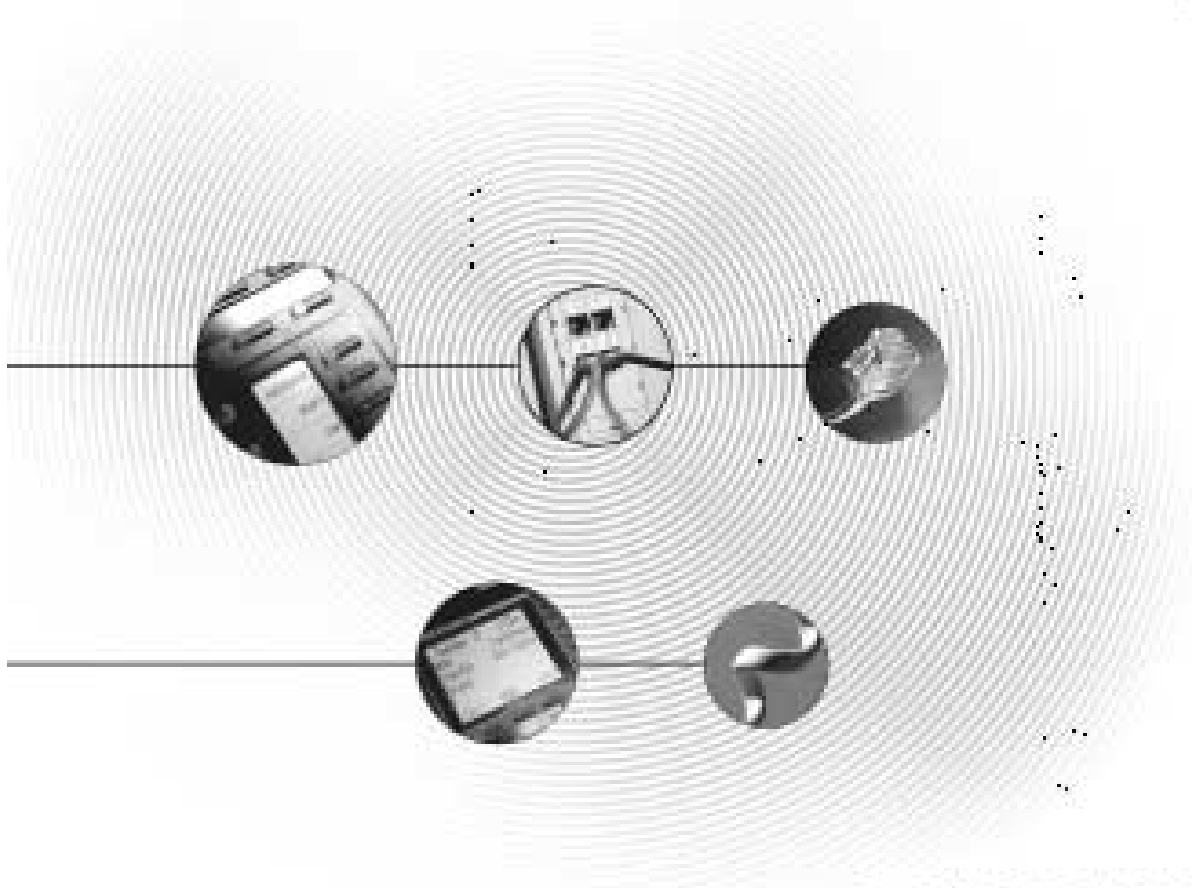

**COMDIAL**  
The Rising Star

***This User's Guide is for the following system :***

***DXP, DXP Plus, FXS and FXT  
Digital Communication Systems.***

*This user's guide applies to the following telephone models:*

- Impact 8124S-\*\* Rev. A and later.
- Impact 8112S-\*\* Rev. A and later.
- Impact 8112N-\*\* Rev. A and later.
- Impact SCS 8212S-\*\* Rev. A and later.
- Impact SCS 8212N-\*\* Rev. A and later.

Contact your Comdial dealer for updates of this as well as other Comdial publications.

## ***About This Book***

This user's guide serves as both an introduction for new speakerphone users and a reference for experienced users.

### ***Introduction***

The first chapter of the manual describes the initial setup and adjustments necessary to begin using your speakerphone.

#### **1 Getting Started**

The following chapters describe the basic and advanced features of the Common Code Based DXP, DXP Plus, FXS and FXT systems.

- 2 Answering Calls**
- 3 Making Calls**
- 4 Advanced Call Handling**
- 5 Nonverbal Messaging**
- 6 Programming**
- 7 Other Advanced Features**

Following the advanced features descriptions are a reference table, a glossary that defines many general phrases and abbreviations which may not be familiar to users, tips on speakerphone use for the new user described in Appendix C and all the features available for the DXP, DXP Plus, FXS and FXT systems are described in Appendix E.

- Appendix A** Quick Reference Guide
- Appendix B** Glossary
- Appendix C** Speakerphone Characteristics
- Appendix D** Feature Networking Support

Finally, at the end of this publication, an index provides a detailed reference to the feature locations.

#### **Index**

**NOTE:** Throughout this book, all references to fixed buttons (keypad, *DSS/BLF*, *SPEAKER*, *HOLD*, etc...) are printed in upper case, italic type; for example, “**PRESS INTERCOM** .”

All references to interactive buttons (which are used to make selections on the speakerphone display) are printed in upper case, bold italic type; for example, “**SELECT OPTIONS** .”

Also, to eliminate confusion, the text of this guide instructs users to “**PRESS**” fixed buttons of the telephone and “**SELECT**” interactive buttons as in the examples above. Instructions to “**DIAL**” refer to numbers or symbols on the keypad.

## ***System-to-System Network***

The system also provides capabilities for either a local stand-alone system or a system-to-system network. System-to-system networking connects several DXP, DXP Plus, FXS and FXT systems together in an arrangement that allows unified communications through the system. For a complete list of features and their properties see Appendix E, Feature Networking Support.

# Contents

<b>1</b>	<b>Getting Started . . . . .</b>	<b>1</b>
	Setting Up Your Station . . . . .	1
	Understanding the Basic Functions . . . . .	6
	Your Station's Buttons . . . . .	8
	Your Station's Display Lights . . . . .	10
	Supported Telephone Models . . . . .	12
<b>2</b>	<b>Answering Calls . . . . .</b>	<b>13</b>
	Answering Outside Calls . . . . .	13
	Answering Intercom Calls . . . . .	14
	Night-Transferred Calls -Line Access From Any Station . . . . .	15
	Holding Calls . . . . .	16
	Call Pickup . . . . .	18
	Receiving Subdued Off-Hook Voice Announcements (SOHVA) . . . . .	20
	Do Not Disturb Condition. . . . .	22
<b>3</b>	<b>Making Calls . . . . .</b>	<b>23</b>
	Making Outside Calls . . . . .	23
	Making Intercom Calls . . . . .	24
	Automatic Dialing. . . . .	25
	Redialing . . . . .	26
	Paging . . . . .	28
	Camping On - Busy Station, Automatic Callback . . . . .	29
	Advanced Camping On Options . . . . .	30
	Sending Subdued Off-Hook Voice Announcements (SOHVA) . . . . .	32

---

<b>4</b>	<b>Advanced Call Handling</b>	<b>33</b>
	Waiting For A Line (Queuing)	33
	Conferencing	34
	Call Forwarding	36
	Call Forward Outside System (CFOS)	38
	Account Codes	39
	Call Parking	40
	Call Transferring	42
	Other Call Transferring Options	44
<b>5</b>	<b>Nonverbal Messaging</b>	<b>47</b>
	LCD Message Delivery	47
	Message Waiting Light and Messaging	50
	Response Message Delivery	51
<b>6</b>	<b>Programming</b>	<b>53</b>
	DSS Numbers	53
	Speed Dial Numbers	54
	Response Message Button	57
	Feature Buttons	58
<b>7</b>	<b>Other Advanced Features</b>	<b>61</b>
	Line Groups	61
	Automatic Redial (8124S, 8112S and 8212S only)	62
	Tracker Paging System	64
	Volume Control	66
	Default Volume Control	68
	Background Music (not available on 8112N or 8212N)	69
	Automatic Set Relocation	70
	DSS/BLF Console Operation	71

**A Feature Access Codes . . . . . 73**

**B Glossary . . . . . 79**

**C Speakerphone Characteristics . . . . . 87**

**D Feature Networking Support . . . . . 89**

**Notes**



**1**

## Getting Started

### *Welcome*

Congratulations and thank you for using a Comdial telephone! Your digital station is supported by a communication system with hundreds of built-in, standard features. This manual serves as a helpful guide for using these various functions.

The sections in this introductory chapter help you initially set up your station and become familiar with the controls and indicators. The remaining sections are titled as follows:

- Setting Up Your Station
- Understanding the Basic Functions
- Your Station's Buttons
- Your Station's Display Lights
- Supported Telephone Models

### Setting Up Your Station

When your new station arrives, the system installer unpacks your station and connects the line to a system jack. The following sections describe a few initial adjustments that will allow you to quickly begin making and answering calls with some of the most basic features.

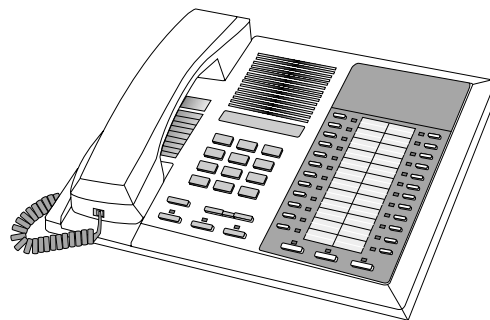

*An Impact 8124 Station*

## Positioning Your Station

You should adjust the position of the station on your desk or table to suit your individual needs and, if applicable, maximize the performance of the sound activated features. When using a speakerphone, the microphone and loudspeaker are farther from you than when you use a handset. Some positioning tips for speakerphones to consider include:

- For the microphone to best detect your voice, speak within three feet of it and face the station.
- Background noise may prevent the sound-activated switches from operating properly. Avoid placing the speakerphone where it will detect sounds from typewriters, keyboards, printers, paging systems, and other equipment.
- Place the speakerphone on a hard surface and away from table edges. Do not place the telephone in corners or enclosures. Do not let obstructions come between you and the microphone.

If you are using an Impact SCS model, your telephone has an adjustable pedestal to allow you to select the most comfortable viewing angle. When you receive the telephone, the pedestal is in its lowest position—flush against the pedestal.

### **To adjust the pedestal (Models 8212S and 8212N only),**

1. **GRASP** the rear of the pedestal base firmly with one hand **AND LIFT** the rear portion of the telephone upward with your other hand.
2. **LIFT** the telephone upward with one hand **AND RAISE** the telephone supporting arms upward with your other hand. (Notice there are three sets of notches under the telephone corresponding to the three positions available.)
3. When the telephone is at the desired height, **SELECT** the closest pair of notches **AND INSERT** the supporting arms in the notches. **PRESS DOWN slightly** on the telephone **UNTIL** you feel the supporting arms snap into place.

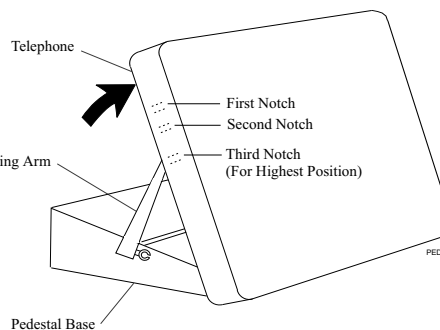

*Adjusting The Pedestal*

Also remember, as with any piece of electronic equipment, your telephone may be damaged by contact with liquids. So please try to place the telephone in an area that is free from the danger of spills.

## Setting a Personal Ringing Tone

You can choose one of eight different ring tones for your telephone. Often, when several telephones are located close together, each user chooses a different personal ring tone.

*To select one of the ring tones, proceed as follows:*

1. **PRESS INTERCOM.**
2. **DIAL**   .
3. **DIAL** number (  to  ) to select ring tone.
4. The next time your telephone rings, you will hear the new ring tone.

## Setting Volume Levels

The volume control on your telephone is a multi-purpose control you use to set the volume (loudness) of the ringer, the speaker, and the handset.

*To set the ringer loudness level,*

1. While your telephone is on-hook and idle, **PRESS** the **VOLUME UP OR VOLUME DOWN** button once for each change in loudness you desire. The ringer sounds once for each change as an example of the current setting.

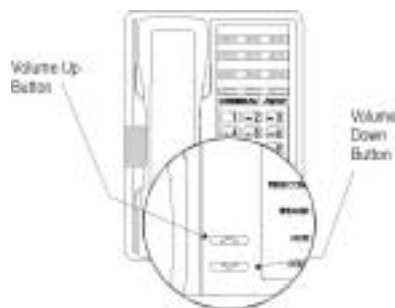

*Impact SCS Volume Buttons*

**NOTE:** If you set the ringer to the “off” position, your telephone will sound a short ring burst once for each call you receive at your station.

**NOTE:** On the 8112N, the ringer volume is controlled by a three-position switch on the bottom of the telephone. There is no handset volume control.

**To set the speaker and handset loudness levels,**

1. **PRESS** *INTERCOM* button.
2. **PRESS** the *VOLUME UP* **OR** *VOLUME DOWN* button once for each change in speaker volume that you desire.
3. **LIFT** handset.
4. **PRESS** the *VOLUME UP* **OR** *VOLUME DOWN* button once for each change in handset volume that you desire.

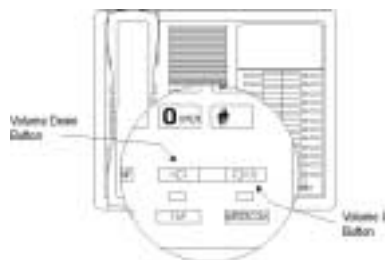

*Impact 8124 Volume Control*

**NOTE:** When a call ends, the system resets the speaker and handset volume of all future calls to the programmed (default) setting. For instructions in setting your station's default volume, see Default Volume Control section in the system specific Advanced Features chapter.

## **Answering and Making Calls**

Your station is now properly configured to answer and making calls to both stations within your system (intercom calls) and outside lines. Remember that when dialing an outside number, you must first select a line to connect your system to the local exchange.

***When you hear outside ringing (two long bursts),***

1. **PRESS** flashing line button.
2. **SPEAK** toward telephone **OR** **LIFT** handset if privacy is desired.

***When you hear intercom ringing (two short bursts),***

1. **PRESS** *INTERCOM*.
2. **SPEAK** toward telephone **OR** **LIFT** handset if privacy is desired.

***To dial an outside number manually,***

1. **PRESS INTERCOM.**
2. **DIAL**  **OR** other line button to select line (See *Line Groups* in the system specific Advanced Features chapters for more information on selecting an outside line).
3. **LISTEN** for dial tone.
4. **DIAL** number.
5. **LIFT** handset if privacy is desired.

***To dial an intercom number manually,***

1. **PRESS INTERCOM.**
2. **DIAL** extension number (called telephone will ring or tone will be heard).
3. **SPEAK** toward telephone **OR LIFT** handset if privacy is desired.

## Understanding the Basic Functions

Your station provides many versatile features for your use. These features are explained in terms of what they allow you to do.

### **Message-Waiting Light**

- Indicates that a message awaits pick up.

### **Microphone Opening (not available on 8112N and 8212N)**

- Allows hands-free operation of station (speak clearly toward microphone opening).

### **Speaker (not available on 8112N and 8212N)**

- Sounds distant party's voice.
- Sounds ringing and call-in-progress tones.

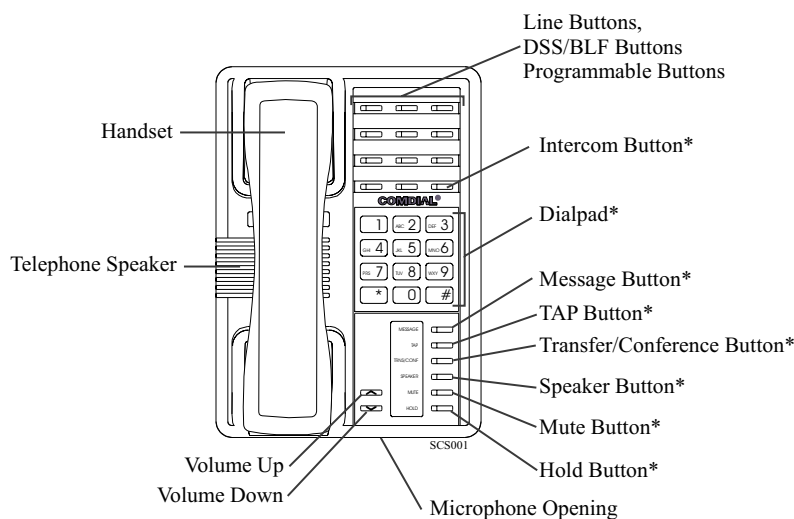

**\*NOTE:** These are default button locations.  
Your system installer may have reprogrammed  
these buttons to better suit your needs.

Impact SCS 8212S-\*\* Speakerphone

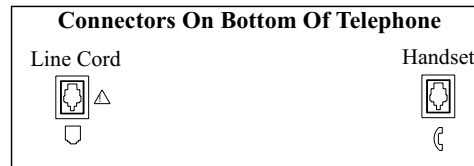
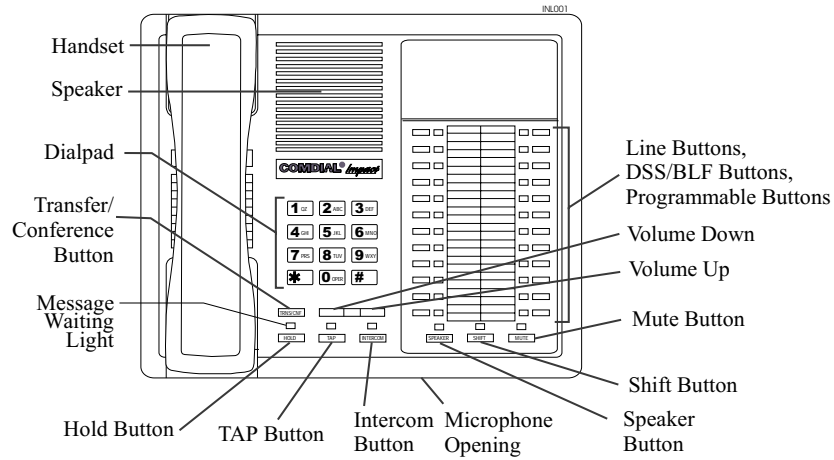

Impact 8124S-\*\* Speakerphone

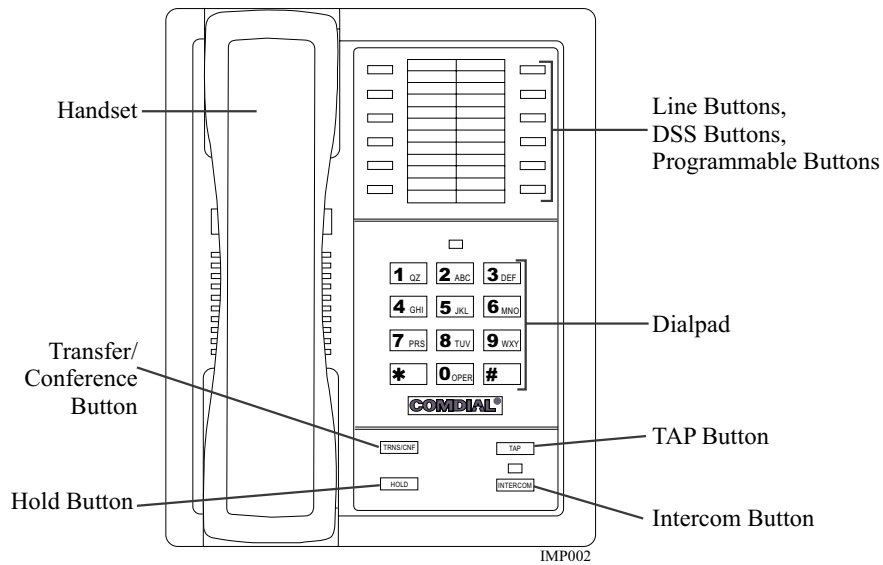

Impact 8112N-\*\* Telephone

## **Your Station's Buttons**

### ***Hold Button (HOLD)***

- Places a line or intercom call on hold.
- Stores pauses in number sequences during programming.
- If multiple held calls feature is available, scans or scrolls through calls placed on hold (when hold light is flashing).

### ***Intercom Button (INTERCOM)***

- Selects an intercom line.
- Allows you to initiate many of the telephone's features.

### ***Mute Button (MUTE)***

- Keeps the person on the line from hearing your conversation.

### ***Direct Station Select/Busy Lamp Field Buttons (DSS/BLF)***

- Allow you to store numbers for automatic dialing functions.
- Allow you to store telephone extension numbers for Direct Station Selection (DSS).
- May be programmed as a feature button.
- May be designated a line button by your system installer.

### ***Message Button (MESSAGE) (8212S and 8212N only)***

- Allows you to activate the message waiting light at another station by pressing this button and dialing the extension.
- Allows user to quickly return the call of another station that left a message using the indicating light.

### ***Shift Button (SHIFT)***

- Allows you to enter a second tier for storing and/or automatically dialing speed dial numbers. (That is, you can store two speed dial numbers at every programmable button location—one in the regular tier and one in the second tier). You activate the shift function by pressing this button and turning the shift light on before storing or automatically dialing a speed dial number from the second tier.

### ***Speaker Button (SPEAKER) (not available on 8112N and 8212N)***

- Turns your speaker on or off.
- Disconnects a call when you are on a handsfree call.
- Ends or cancels programming.



**Tap Button (TAP)**

- Recalls dial tone or generates a hookflash.
- Retrieves held calls or last call placed on hold.

**Transfer/Conference Button (TRNS/CONF)**

- Transfers calls.
- Sets up conference calls.

**Volume Control (VOLUME UP or VOLUME DOWN)**

- Regulates the volume of the ringer, speaker, handset, headset, background music, and group listening mode.

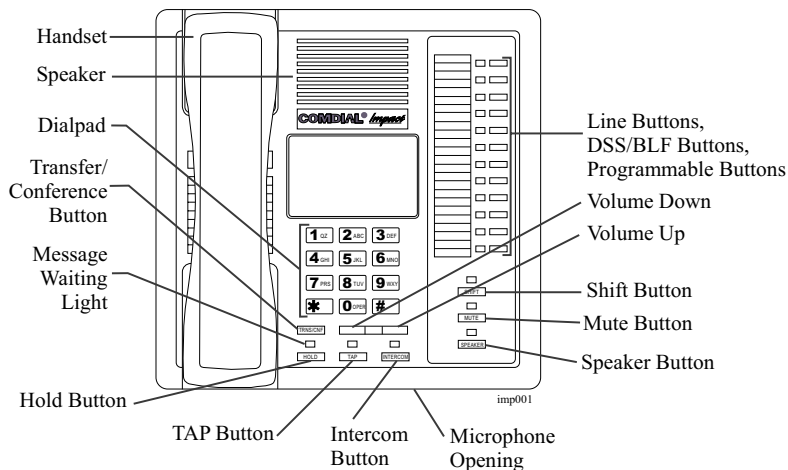

Impact 8112S-\*\* Speakerphone

## Your Station's Display Lights

The lights (LEDs) on your LCD speakerphone indicate the status of lines, features, and intercoms.

### ***Busy Lamp Field (BLF) lights (next to a Direct Station Select/Busy Lamp Field or DSS/BLF programmable button):***

- Steady red = station is in use.
- Flashing red = station is receiving a call.
- Winking/Fluttering red = message-waiting light set for you by station associated with that DSS button.

### ***Next to a line button:***

- Steady green = this is your line, either on-hook (in a handsfree mode) or off-hook, when the line is active.
- Steady red = another station is using this line.
- Flashing red = a call is coming in on this line.
- Flashing orange = this line will be answered when you lift the handset.
- Winking green = your line is on hold.
- Winking red = the call has been placed on hold by another station.
- Fluttering orange or green = your line has recalled from hold.
- Fluttering red = the line put on hold by another station has recalled.

**NOTE:** You can find the programmable buttons that the installer designates line buttons in the same location as the DSS/BLF buttons. Ensure that these buttons are labeled correctly to indicate their unique features.

### ***Next to a fixed feature or programmable feature button:***

- Steady red = the feature is on.
- Steady off = the feature is off.

**NOTE:** You can find the programmable buttons that the installer designates feature buttons through user programming in the same location as the DSS/BLF programmable buttons. Ensure that these buttons are labeled correctly to indicate their unique features.

### ***Above the MUTE button:***

- On steady = called party cannot hear your conversation.

**Next to INTERCOM button:**

- Steady green or red = you are using your intercom.
- Fluttering red = an LCD message is set on your telephone for others to receive when calling.
- Flashing orange = someone is calling your extension or a call is being transferred to you.

**Above the HOLD button:**

- (Non-SCS Series models) Flashing/Fluttering red = message waiting.
- Winking green = a line is on hold at your station (DXP, DXP Plus, FXS and FXT Systems only).

**Next to the MESSAGE button (SCS Series Models only):**

- Winking green = message awaits pick up.

**Above the SPEAKER button:**

- On steady (with the telephone on hook and busy) = speakerphone mode
- On steady (with telephone on hook and idle) = background music is turned on.

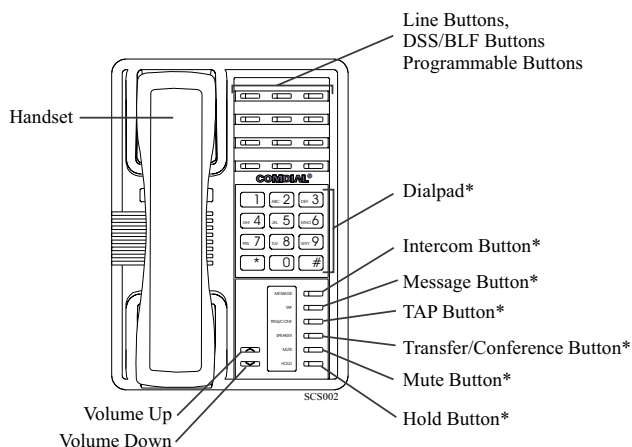

**\*NOTE: These are default button locations.  
Your system installer may have reprogrammed  
these buttons to better suit your needs.**

Impact SCS 8212N-\*\* Telephone

## Supported Telephone Models

This user's guide covers five different telephone models. The overall operation of each of the telephones is very similar. There are, however, several differences that are summarized in the following table.

Models	Exceptions
<p><b>Non-speakerphone Models</b> (8112N and 8212N)</p>	<ul style="list-style-type: none"> <li>• No speakerphone capability. Therefore, you must lift the handset to perform any telephone functions: making calls, answering calls, programming your telephone, etc.</li> <li>• Cannot receive voice announce calls.</li> <li>• Cannot use the Group Listen feature.</li> <li>• Cannot use the Background Music feature.</li> </ul>
<p><b>Impact Non-speakerphone Model</b> (8112N)</p>	<ul style="list-style-type: none"> <li>• No LEDs beside its programmable buttons and therefore does not provide any status indications for these buttons.</li> <li>• No mute key.</li> <li>• No handset volume control.</li> <li>• Message waiting light is above the dialpad.</li> </ul>
<p><b>Impact Speakerphone Models</b> (8112S and 8124S)</p>	<ul style="list-style-type: none"> <li>• Has a rocker switch style volume control instead of separate volume up and volume down buttons.</li> <li>• Message waiting light is above the <i>HOLD</i> button.</li> </ul>
<p><b>Impact SCS Speakerphone Models</b> (8212S and 8212N)</p>	<ul style="list-style-type: none"> <li>• The IMIST module only works with the 8212S and 8212N telephones.</li> <li>• Has a dedicated message button with an associated light beside it.</li> <li>• Supports the ICVOL handset with independent volume control.</li> </ul>

**2****Answering Calls****Answering Outside Calls**

A call that rings on an outside line sounds long, single-tone bursts and lights the line status light. If the installer enabled ringing line preference at your station, an orange light flashes next to the line that your station answers when you lift the handset; a red light will flash for any other ringing line.

***When you hear outside ringing (two long bursts) and observe an orange flashing light,***

1. For privacy, **LIFT** handset.
2. For speakerphone, **PRESS** flashing line button **AND SPEAK** toward telephone.

***When you hear outside ringing (two long bursts) and observe a red flashing light,***

1. **PRESS** flashing line button.
2. **SPEAK** toward telephone **OR LIFT** handset if privacy is desired.

## Answering Intercom Calls

An intercom call is a call between two system stations. If a speakerphone, your station will receive intercom calls in one of two ways depending upon system programming. In a *voice-first* setting, a short tone followed by the caller's voice heard on the speaker. With a *tone-first* setting, the telephone rings in a distinctive pattern and the receiving station must take action to answer. Of course, if either station is not speakerphone equipped, all calls will arrive *tone-first*.

You can block voice-announce calls if you wish. See the discussion titled *Blocking Voice Announce Calls* for details.

### ***When you hear an intercom tone followed by a caller's voice,***

1. **SPEAK** toward the telephone to answer, **OR LIFT** handset if privacy is desired.

### ***When you hear intercom ringing (two short bursts),***

1. **PRESS INTERCOM.**
2. **SPEAK** toward telephone **OR LIFT** handset if privacy is desired.

## **Night-Transferred Calls -Line Access From Any Station**

The system attendant can transfer incoming calls to a particular station or stations for off-hour ringing.

### ***If your telephone rings,***

1. **PRESS** line button with flashing light.
2. **LIFT** handset to talk.

### ***When you hear loud ringing anywhere in the system,***

1. **LIFT** handset.
2. **PRESS INTERCOM.**
3. **CHOOSE** ringing zone:
  - **DIAL** 65 through 68 to select ringing zone (1-4).
  - **DIAL** 69 to answer for any zone.

## Holding Calls

You can place a call on hold and retrieve it later. With a regular hold, you can pick up the held call at your telephone or another user can pick the call up at a telephone sharing the held call line.

### *To place a call on hold,*

1. **PRESS HOLD.** The light above your *HOLD* button begins to blink.

### *To retrieve a held call,*

1. **PRESS** line button of the held call (with winking green light), **OR PRESS TAP.**
2. **SPEAK** toward telephone **OR LIFT** handset if privacy is desired.

## *Exclusive Hold*

With an exclusive hold condition, you must pick up the held call at your telephone; no other telephone has access to it.

### *To place a call on exclusive hold,*

1. **PRESS HOLD** twice.

### *To retrieve exclusive hold,*

1. **PRESS** line button of held call (with winking green light), **OR PRESS TAP.**
2. **SPEAK** toward telephone **OR LIFT** handset if privacy is desired.

## *Handling Hold Recalls*

After a call has been on hold for the period of time (set by the installer of your system), the system causes four quick hold recall tone bursts to sound at your telephone, the flash rate of the line button becomes faster and the light becomes orange. If the call is on exclusive hold, it will revert to manual hold after the hold recall period.



***If a held line is recalling, choose one of the following:***

1. **PRESS HOLD** (station button) to place the call on hold at your station and restart hold timer.
2. **PRESS** line button (with flashing orange light) **OR PRESS TAP** to retrieve the call.

***Directed Hold***

The installer can add a directed station hold feature to your telephone. With this feature, you can place a call on hold at a distant station or pick up the held call that has been on hold the longest length of time at another telephone.

***To place a call on directed station hold,***

1. **ANSWER** call.
2. **PRESS INTERCOM OR TRNS/CONF** if intercom call.
3. **DIAL** \*90.
4. **DIAL** extension number of station to receive held call.
5. **HANG UP**.

***To retrieve a held call at another station,***

1. **PRESS INTERCOM**.
2. **DIAL** #90.
3. **DIAL** extension number of station where call is being held.
4. **PRESS DSS/BLF** button **OR TAP** to answer call.

## Call Pickup

The Impact system offers three distinct methods to answer incoming calls that are ringing at other stations.

### *Group Call Pickup*

The installer often arranges several telephones together in a user group. If your telephone is so arranged, you can answer calls that are ringing at other stations within your particular group.

#### *To answer a call that is ringing within your group,*

1. **PRESS INTERCOM.**
2. **DIAL**  .
3. **SPEAK** toward telephone, **OR LIFT** handset if privacy is desired.

### *Directed Call Pickup*

Also, you can answer calls that ring at any telephone in the system if you know the telephone's extension number.

#### *To answer a call that is ringing at any telephone in the system,*

1. **PRESS INTERCOM.**
2. **DIAL**  .
3. **DIAL** extension number of ringing telephone.
4. **SPEAK** toward telephone, **OR LIFT** handset if privacy is desired.

### *Pickup For Monitored Stations*

Your telephone may have the personal intercom number of another telephone appearing at a programmable button location. You can use the light associated with this button to monitor the status of that telephone, and you can press the button to make a call to that telephone if you wish.

### *To monitor another telephone,*

1. **OBSERVE** the BLF light indications next to the Direct Station Select (*DSS/BLF*) button:
  - Off = Station is idle.
  - Flashing (if enabled) = Station has an incoming call.
  - On = Station is busy.

### *To call an idle monitored station or to answer one that is ringing,*

1. **NOTE** the BLF light condition.
2. **PRESS** assigned *DSS/BLF* button.
3. **SPEAK** toward telephone, **OR LIFT** handset if privacy is desired.

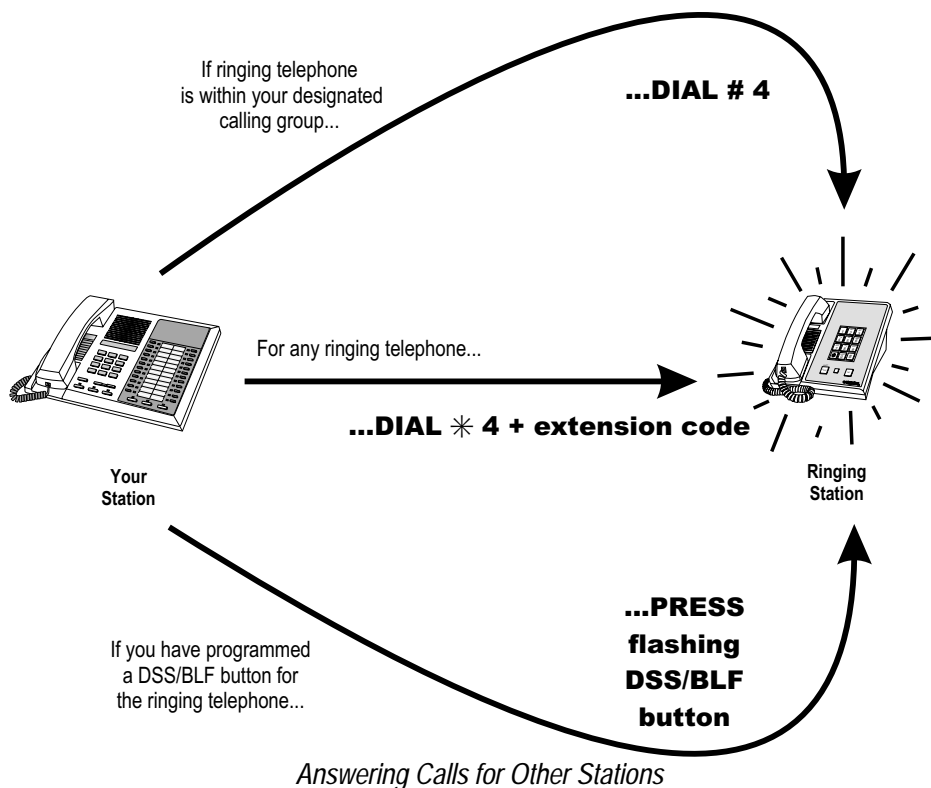

## Receiving Subdued Off-Hook Voice Announcements (SOHVA)

### *Handling an Incoming SOHVA*

SOHVA allows an intercom caller to break into your call by making an announcement through your handset receiver. The distant party that you are currently talking to cannot hear the announcement made by the SOHVA caller.

#### *To respond to a SOHVA verbally (not available on 8112N),*

1. **PRESS AND HOLD MUTE.**
2. **SPEAK** into handset. Distant party cannot hear your response.
3. **RELEASE MUTE** after response is complete to return to distant party.

#### *To respond to a SOHVA nonverbally through Response Messaging (if announcing station has an LCD Speakerphone),*

**NOTE:** See page 58 for instructions on programming a RESPONSE MESSAGE button.

1. **PRESS** programmed RESPONSE MESSAGE button. (Message appears in the display of the telephone making the SOHVA).
2. **CONTINUE** your current call with distant party. (SOHVA caller is automatically disconnected from your telephone. If caller is not sending from an LCD Speakerphone, no message is sent and call is disconnected.)

#### *To respond to a SOHVA by blocking (see below for more information),*

1. **PROGRAM** Voice Announce Block when you hear SOHVA tone. (SOHVA call is disconnected).

**NOTE:** A station that is currently active in speakerphone mode can not receive a SOHVA.

## Voice Announce Blocking

If your system installer makes Voice Announce Blocking available, you can prevent voice announcements from sounding over your telephone speaker if you wish. This feature also blocks Subdued Off-Hook Voice Announcements (SOHVA) and generates a tone in response to attempted SOHVAs.

### *To block all voice-announced calls,*

1. **PRESS INTERCOM.**
2. **DIAL** \*2.

### *To unblock all voice-announced calls,*

1. **PRESS INTERCOM.**
2. **DIAL** #2.

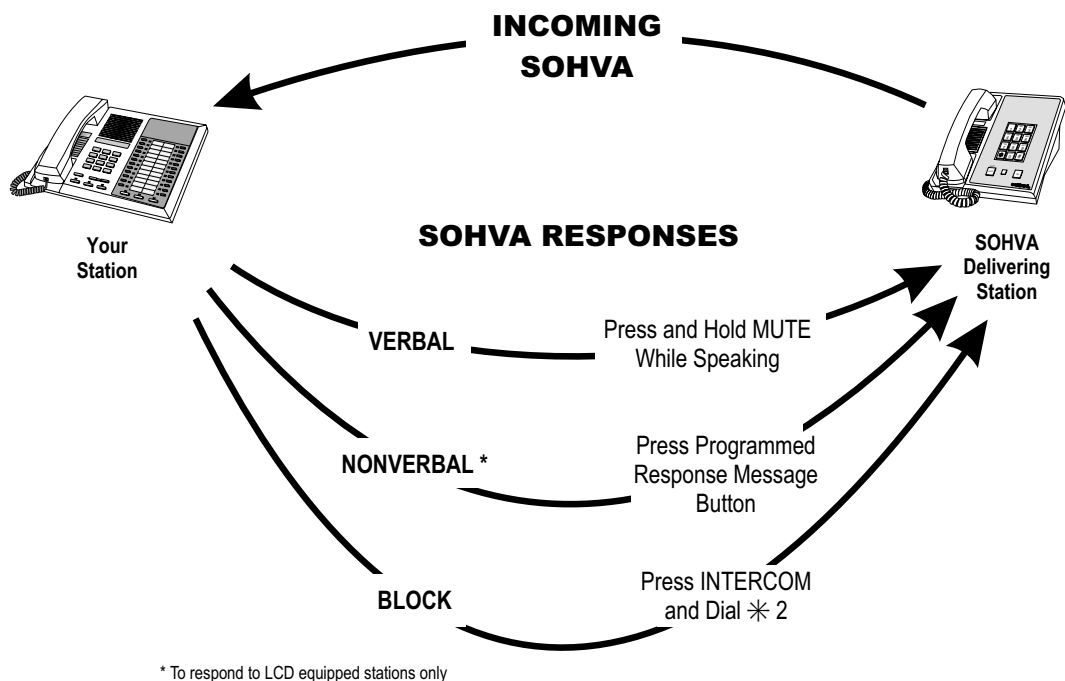

*Answering a SOHVA*

## Do Not Disturb Condition

The Do Not Disturb (DND) feature keeps calls from ringing at your station and makes your station appear to be busy to intercom calls.

### *To enable DND, choose one of the following:*

1. **PRESS** programmed DO NOT DISTURB button. The light next to the DO NOT DISTURB button turns on when the feature is active,
2. **PRESS INTERCOM AND DIAL**   .

### *To override a do not disturb condition at another telephone,*

1. **MAKE** intercom call **AND HEAR** DO NOT DISTURB tone.
2. **DIAL**    (called party will hear several short tone bursts).
3. **WAIT** for reply.

### *To disable DND,*

1. **PRESS** programmed DO NOT DISTURB button. The light associated with the DO NOT DISTURB button turns off when the feature is disabled,
2. **PRESS INTERCOM AND DIAL**   .

<p><b>NOTE:</b> See page 58 for instructions on programming an ACCOUNT CODE button.</p>
---

**3****Making Calls****Making Outside Calls**

You can manually dial a number over any telephone line you select. Or, if the installer assigned a prime line or the idle line preference feature, your station automatically selects a line for use when you lift the handset.

**NOTE:** 8112N and 8212N users must lift handset before any dialing activity.

***To dial an outside number manually,***

1. **PRESS INTERCOM OR LIFT** handset if privacy is desired. (8112N and 8212N users must lift handset.)
2. **DIAL**  **OR** other line button to select line (See *Line Groups* in the system specific Advanced Features chapters for more information on selecting an outside line).
3. **LISTEN** for dial tone.
4. **DIAL** number.

If your station has been assigned a prime line, you will not have to select a line before dialing outside your system.

***To dial an outside number using your prime line,***

1. **PRESS SPEAKER OR LIFT** handset if privacy is desired. Outside line is automatically selected. (8112N and 8212N users must lift handset.)
2. **LISTEN** for dial tone.
3. **DIAL** number.

## Making Intercom Calls

There are two methods for making intercom calls. One method causes the called telephone to ring (tone-first). The other method causes your voice to sound out at the called telephone (voice-first). Your installer can set the system to deliver either tone-first or voice-first calling.

**NOTE:** The following instructions assume a tone-first setting. You can change a call to voice announce signaling for that call simply by pressing the INTERCOM button again after dialing the extension number or by pressing the DSS/BLF button again.

### *To manually cause the other telephone to ring (tone calling),*

1. **PRESS INTERCOM OR LIFT** handset if privacy is desired. (8112N and 8212N users must lift handset.)
2. **DIAL** extension number (called telephone will ring).

### *To tone call automatically,*

1. **PRESS DSS/BLF** button (called telephone will ring). (8112N and 8212N users must lift handset first.)

**NOTE:** The following instructions assume a voice-first default setting. You can change a call to a tone signaling for that call simply by pressing the INTERCOM button again after dialing the extension number or by pressing the DSS/BLF button again.

### *To voice announce manually,*

1. **PRESS INTERCOM.**
2. **DIAL** extension number.
3. **SPEAK** your announcement.

### *To voice announce automatically,*

1. **PRESS DSS/BLF** button.
2. **SPEAK** your announcement.



## ***Automatic Dialing***

Automatic dialing provides one- or two-button speed dialing using programmable buttons at which you have previously stored numbers. There are two types of speed dial numbers: (1) numbers that you store for your own use (personal speed dial numbers), and (2) numbers that the system attendant stores for everyone's use (system speed dial numbers).

**NOTE:** When you call from a station not equipped with a speaker (for example, 8112N and 8212N) you must **LIFT** the handset **AND PRESS TAP** before initiating any automatic dialing activity.

***To automatically dial a speed dial number stored at one of the programmable buttons on your station, choose one of the following:***

1. **PRESS** programmed speed dial button (line selection is usually a part of the stored speed dial number).
2. **PRESS SHIFT AND** programmed speed dial button (to choose number stored as second choice at that button).

***To speed dial a personal speed dial number stored at the dial pad,***

1. **DIAL** speed dial number on dial pad (  to  ).

**NOTE:** If you are already on a line, you must press SHIFT before dialing the personal or system speed dial numbers that are stored at the dial pad. Also, if a speed dial number's preselected line is in use, the speed dial will not engage.

***To speed dial a system speed dial number stored at the dial pad,***

1. **DIAL**  **AND** system speed dial number.

## ***Redialing***

If made available by your installer, you may also program your system to automatically redial a busy or ring-no-answer number. See page 62 for further instructions on setting up your station for automatic redial.

### ***Redial - Last-Dialed Number***

The system *temporarily* saves the first 16 digits of the last manually dialed number for your redial use—if the last number you called is busy or is not answering, you can redial it once or initiate repeated redialing. Subsequent dialing activity overwrites a temporarily saved number.

#### ***To redial the last-dialed number,***

1. **PRESS SPEAKER OR HANG UP** handset to disconnect current ringing or busy tone.
2. **DIAL** .
3. **LIFT handset OR LISTEN** for ringing or busy tone over the telephone speaker:

### ***Redial Programming (Storing Numbers)***

You can permanently store a number at any programmable button location that does not currently have a number or feature associated with it.

**NOTE:** For programming of a SAVED NUMBER REDIAL button at your station, refer to Feature Buttons section on page 58.

#### ***To permanently store a number you've just dialed,***

1. **DIAL** number.
2. **PRESS** programmed SAVED NUMBER REDIAL button (see *Feature Buttons* section in system specific Programming chapter for set up details).

***To dial the saved number,***

1. **PRESS SPEAKER OR LIFT** handset if privacy desired.
2. **PRESS** button where number is saved, **OR PRESS** programmed SAVE NUMBER REDIAL button.

If a distant party tells you an important telephone number and you want to immediately save it for later redial, you can use a SAVE NUMBER REDIAL button to save the first 16 digits of that number.

***To store a number while you are on a call,***

1. **PRESS** programmed SAVE NUMBER REDIAL button twice (the display prompts you to dial a number).
2. **DIAL** the number that you wish to save (the system immediately saves the number for later redial; it does not dial it over the line you are on now).

***To later redial the saved number,***

1. **PRESS** line button to select a line.
2. **PRESS** programmed SAVE NUMBER REDIAL button (system automatically dials the number that you saved earlier).

## Paging

Your system provides an all-call or a zone page feature that you access by dialing special codes. This arrangement sounds your voice announcement through the telephone speakers or through an external paging unit.

### *To send a paging announcement,*

1. **LIFT** handset.
2. **PRESS INTERCOM.**
3. **DIAL**  through  for zones 1–8.

**NOTE:** Zone 1 (code ) provides an all-call function in the default mode.

4. **MAKE** announcement.
5. **REMAIN** on line if awaiting a reply (known as a Meet-Me page), **OR HANG UP** handset.

At times other telephone users may page you with instructions to meet them on line. This is known as a Meet-Me page. You can go to the nearest telephone, dial a code, and be in contact with the paging party.

### *To reply to a Meet-Me page,*

1. **LIFT** handset of nearest telephone.
2. **PRESS INTERCOM.**
3. **DIAL** .
4. **MEET** paging party on line.

## **Camping On - Busy Station, Automatic Callback**

If you call another station and receive a busy signal or a Do Not Disturb tone, you can press a button that will cause the system to ring your telephone when the station is available.

### ***To camp on at any busy station,***

1. **DIAL**  .
2. Your telephone immediately hangs up. When the station you called becomes available, your telephone will ring with five short tone bursts.

### ***When you hear five short tone bursts,***

1. **LIFT** handset **OR PRESS INTERCOM**. The other telephone will start ringing.

<p><b>NOTE:</b> If after the ring back tones, you do not press INTERCOM within the time limit set by the installer, the system cancels the call back.</p>
---

### ***To cancel the call back before your telephone sounds the tone bursts,***

1. **PRESS INTERCOM AND DIAL**  .

### ***To camp on at a station with a Do Not Disturb condition set,***

1. **DIAL**   when you hear the DND tone. A call back will occur when called station is no longer set in the Do Not Disturb mode.

## Advanced Camping On Options

### ***Camping On - Idle Station, Automatic Callback***

If you call another station and hear ringing but receive no answer, you can press a button that causes the system to ring your telephone when any activity is initiated at that station.

#### ***To camp on at a station for which you hear ringing but receive no answer,***

1. **DIAL**   **AND HANG UP** handset. Callback will occur after any activity is initiated at the dialed station.

#### ***To cancel the camp-on condition,***

1. **PRESS INTERCOM AND DIAL**  .
2. **HANG UP OR PRESS SPEAKER** to end.

### ***Camping On - Busy Station, Wait For An Answer (Call Waiting)***

If the telephone you have called is busy, you can send a call-waiting tone to the telephone and wait on the line for an answer (you must be using the handset for this feature to work).

#### ***To activate call waiting when you hear a busy signal,***

1. **DIAL**   (called party hears tone).
2. **WAIT** on line for reply.
3. Called party can place the current call on hold or disconnect from the call to answer your call-waiting tone, or choose to ignore your call-waiting tone and continue current conversation.

#### ***To cancel call waiting,***

1. **PRESS INTERCOM AND DIAL**  .
2. **HANG UP OR PRESS SPEAKER** to end.

**To answer a call-waiting tone if you receive one while on a call,**

1. **HEAR** short tone burst in receiver.
2. **PLACE** current call on hold, **OR** complete call **AND HANG UP** (waiting call will ring at your telephone).
3. **LIFT** handset to answer call.

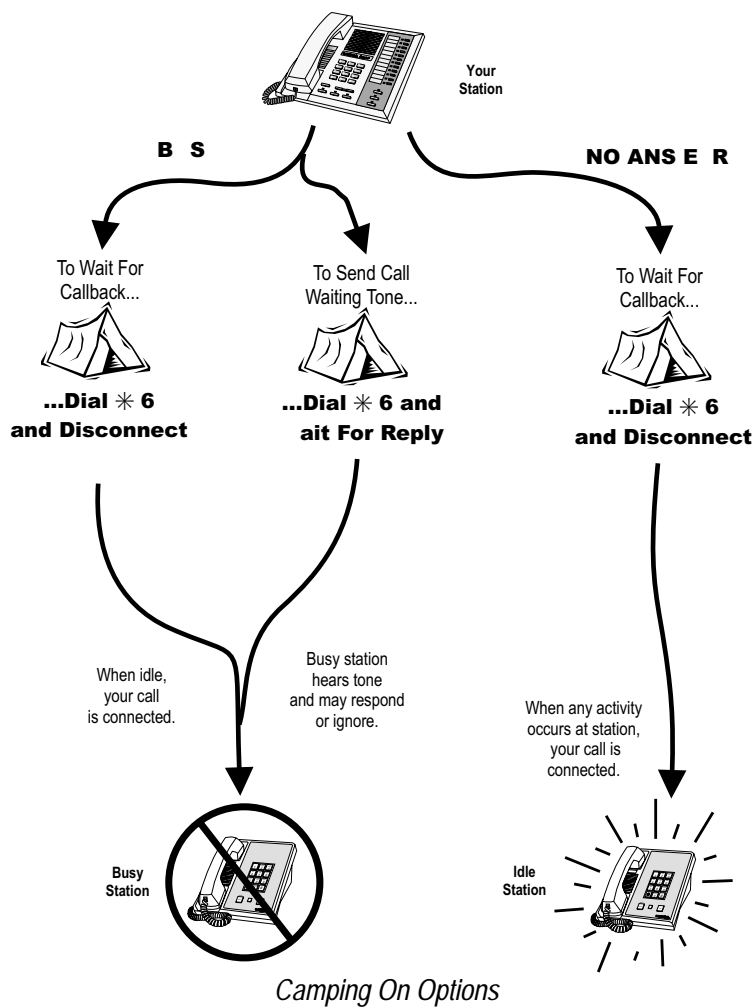

---

## ***Sending Subdued Off-Hook Voice Announcements (SOHVA)***

You can make a private voice announcement to another station that is off-hook and busy on a call if the system is arranged to provide this feature.

### ***Make a SOHVA announcement using the SOHVA button as follows:***

1. **MAKE** intercom call **AND HEAR** busy tone. If called station is on outside line, ring-back tone is heard, but SOHVA is still available.
2. **PRESS** programmed SOHVA button **AND HEAR** several quick tone bursts.
3. **MAKE** announcement (busy tone means that the called telephone is in station mode and you cannot make announcement, that your SOHVA has been denied through system programming, or that the called party has blocked your SOHVA).
4. **WAIT** on line for reply.



**4****Advanced Call Handling****Waiting For A Line (Queuing)**

If all the lines in a line group are busy, you can place your telephone in a queue to await an idle line.

***To queue for a line group,***

1. **PRESS INTERCOM.**
2. **DIAL** the line group access code (see Line Group Access code table on page 61 for your system's codes).
3. **HEAR** busy tone.
4. **DIAL**  .

***If you have line appearance for a particular line and wish to queue for it,***

1. **OBSERVE** the busy status light (LED).
2. **PRESS INTERCOM.**
3. **DIAL**  .
4. **PRESS** line button.
5. When line group is free, your telephone sounds several short tone bursts. When you hear this, lift handset, hear dial tone, and place call.

***To cancel line queuing or line group queuing,***

1. **PRESS INTERCOM.**
2. **DIAL**  .

## Conferencing

When using the DXP system, you can make conference calls that involve up to five parties, including you as the originating party, in any combination of outside lines and intercom parties. When using the DXP Plus, FXS or FXT systems, you can include up to seven parties (in various combinations) in a conference call.

### ***To set up a conference call that includes any combination of outside lines and intercom parties,***

1. **MAKE** first call.
2. **PRESS TRNS/CONF** (call is placed on hold automatically).
3. **SELECT** next line **AND MAKE** next call.
4. **PRESS TRNS/CONF** to establish conference.
5. **PRESS TRNS/CONF** button to add more parties.

### ***To continue conversation on remaining line after other outside lines have dropped out of conference,***

1. **PRESS HOLD**.
2. **PRESS** the line button of the remaining party.

### ***To retrieve a line from hold and bring that party back into the conference,***

1. **PRESS TRNS/CONF**.
2. **PRESS** line button.
3. **PRESS TRNS/CONF**.

If you are involved in a conference call with two outside lines, you can drop out of this established conference call and leave the outside lines in the conference with each other. This is known as an unsupervised conference call.

**To drop out of a conference call you initiated involving outside lines (creating an unsupervised conference),**

1. **DIAL #** (lines remain lighted and in use until one or both outside parties disconnect; when only one party drops out of an unsupervised conference, the other party remains on hold until he hangs up or the line is answered).

**To rejoin an unsupervised conference between two outside lines,**

1. **PRESS TAP.**

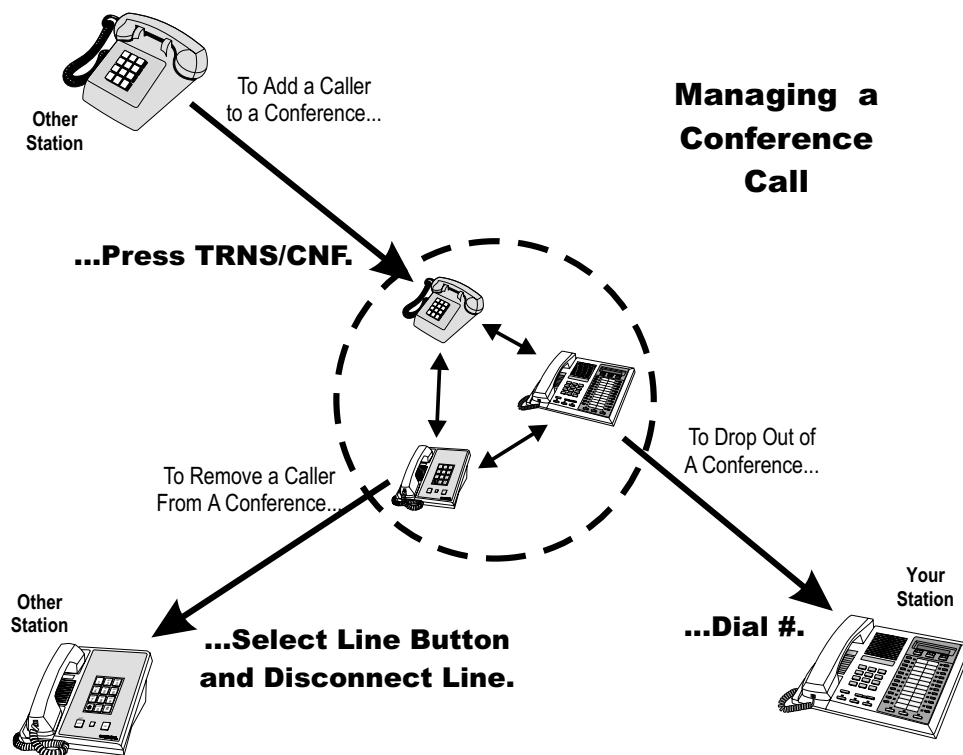

*Conferencing Options*

## Call Forwarding

### *Forwarding a Call*

You can forward the calls that normally ring at your telephone to another telephone. To remind you that the system is forwarding your calls, your telephone sounds a short ring burst each time the system forwards a call.

**NOTE:** You can also use a pre-designated CALL FORWARD button to quickly program your station to forward your calls. See Feature Button section on page 58 for more information on programming.

#### *To forward your calls,*

1. **PRESS INTERCOM.**
2. **CHOOSE** one of the following call forwarding options:
  - **DIAL**    to forward prime line and intercom calls
  - **DIAL**    to forward all calls
  - **DIAL**    to forward prime line and intercom calls after ring no answer or busy line.
  - **DIAL**    to forward all calls after ring no answer or busy line.
3. **DIAL** extension number of telephone to receive your forwarded calls **OR DIAL** desired group intercom number.
4. **PRESS SPEAKER OR HANG UP** to end.

#### *To cancel call forwarding,*

1. **PRESS INTERCOM.**
2. **DIAL**  . Your telephone immediately hangs up.

### *Diverting All Incoming Calls To Another Station*

Call diverting permits you to send an incoming call to another station that you have previously designated. You can divert an incoming call to the designated station whether you are busy or idle.

*To identify the station to receive diverted calls,*

1. **PRESS INTERCOM.**
2. **DIAL** \*55.
3. **DIAL** extension number of station to receive diverted call.

*To divert calls to the designated station,*

1. **HEAR** ringing **AND/OR SEE** flashing line status light.
2. **PRESS** programmed **CALL FORWARD** button (system immediately forwards ringing call to station you designated).

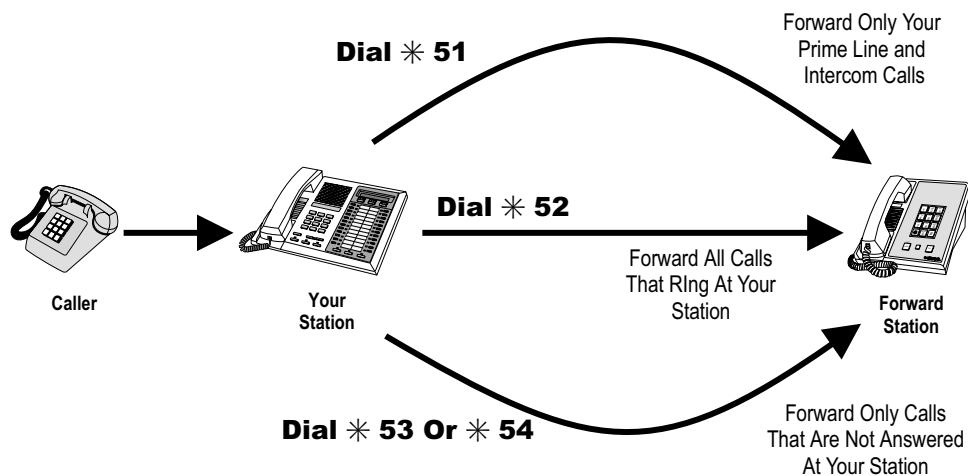

*Call Forwarding Options*

**NOTE:** For programming of a **CALL FORWARD** button at your station, refer to Feature Buttons section on page 58.

## Call Forward Outside System (CFOS)

The Call Forward Outside System\* (CFOS) feature allows you to forward incoming or transferred line calls to telephone numbers outside the system.

### *To activate CFOS with your LCD station,*

1. **PRESS INTERCOM AND DIAL**   .
2. **CHOOSE** the type of call forwarding:
  - **DIAL**  for intercom calls only.
  - **DIAL**  for prime line calls only.
  - **DIAL**  for all calls.
  - **DIAL**  for ring-no-answer intercom calls only.
  - **DIAL**  for ring-no-answer prime line calls only.
  - **DIAL**  for all ring-no-answer calls.
3. **PRESS** the speed dial button programmed with the target number, **OR SELECT** a line **AND DIAL** number (max 16 digits).
4. **PRESS HOLD** for Pause **OR PRESS TAP** for Flash.
5. **PRESS SPEAKER** to end.

### *To deactivate CFOS, choose one of the following:*

1. **PRESS INTERCOM AND DIAL**   .

### *To join an active CFOS call from the CFOS-enabled station,*

1. Note flashing *HOLD* light indicating active CFOS call, and press *TAP*. Join CFOS-forwarded party and CFOS destination in a conference call.

\* Comdial has taken reasonable steps in the design of all product features, including CFOS, which protect against unauthorized or fraudulent access to, or use of, a system, or which protect against unauthorized, fraudulent or unaccounted-for access to, or use of, long distance lines. However, no system is entirely invulnerable or immune from unauthorized or fraudulent access or use, or unaccounted-for access or use, and therefore Comdial disclaims any and all liability, and makes no warranty, express or implied, relating to unauthorized or fraudulent access or use, or unaccounted-for access or use.

## Account Codes

If the installer has arranged your system for account code entry, your display may prompt you to enter an account code after answering a call.

**NOTE:** For programming of an ACCOUNT CODE button at your station, refer to Feature Buttons section on page 58.

### *To enter account code on an incoming call,*

1. **IF** available, **PRESS** programmed ACCOUNT CODE button (the call in progress is not interrupted).
2. **IF** not available, **PRESS INTERCOM AND DIAL**  (call is automatically placed on hold).
3. **DIAL** account code. Your telephone automatically returns to the call after you've dialed the complete account code.

If the installer has arranged your system for account code entry, your display may prompt you to enter an account code before dialing. Depending upon how the installer has programmed your system, these account codes may be "forced"(mandatory) for dialing outside numbers.

### *To enter account code on an outgoing call,*

1. **DIAL**  **OR** other line button.
2. **PRESS INTERCOM** (call is automatically placed on hold).
3. **DIAL**  **AND** account code. **OR PRESS** programmed ACCOUNT CODE button.
4. **LISTEN** for dial tone **AND DIAL** number you are calling.

## Call Parking

### *Parking a Call*

You can place a call on hold in the system so that someone can answer the call from any station that does not have a line appearance for the call. You accomplish this by placing the call in one of many park orbits, where the call remains until it is answered.

#### *To park a call in orbit,*

1. While on the call, **PRESS INTERCOM OR PRESS TRNS/CONF** if intercom call.
2. **DIAL** .
3. **DIAL** code for park orbit (  to  for orbit 10–99).
4. Remember the code for later use or make it known to those who need to know it in order to retrieve the call.

#### *To park a call using a programmed PARK button,*

1. While on the call, **PRESS** the programmed PARK button (the system places the call in a preselected park orbit and lights the PARK light).

#### *To retrieve a call that was placed on hold in the system (parked),*

1. **PRESS INTERCOM**.
2. **DIAL** .
3. **DIAL** code for orbit (  to  for orbit 10–99), **OR PRESS** programmed PARK button.

### *Handling Park Recalls*

When a parked call times out of the system, it returns to your telephone in the form of a park recall (you will hear four short tone bursts at 12-second intervals).

#### *To answer a park recall,*

1. **PRESS** line button. The call will then connect to your station.



**To place a park recall on hold at your station,**

1. ANSWER/RETRIEVE call.
2. **PRESS HOLD.** If the call remains on hold for a period of time, it will ring back to your telephone as a hold recall.

**To re-park a park recall and restart the park timer,**

1. ANSWER/RETRIEVE call.
2. **PRESS INTERCOM AND DIAL \* and park orbit code.** (the system places the call back in its original park orbit where it remains until it is answered or recalls again).

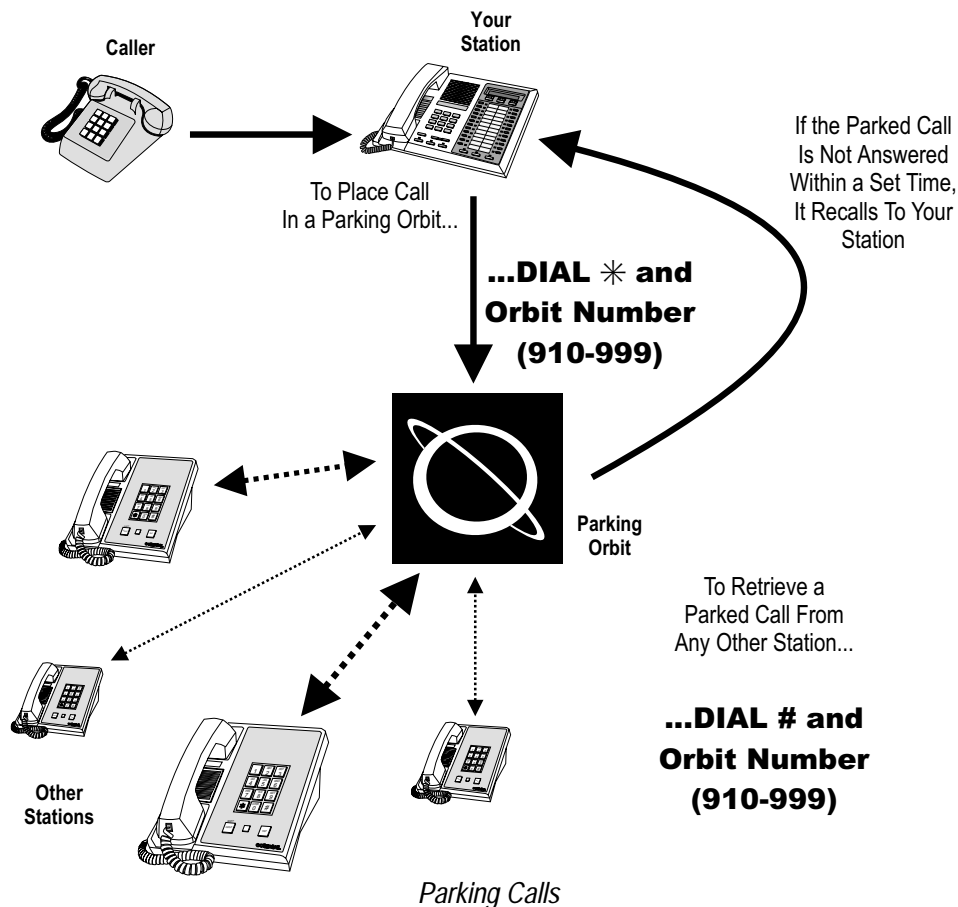

## Call Transferring

### *Screened Call Transfers*

You can answer a call at your station and transfer it to another telephone. If you first identify the caller to the party receiving the transfer (giving that user the opportunity to prepare for the call), you have made a *screened transfer*.

#### *To screen and transfer a call to another telephone in the system,*

1. **ANSWER** call.
2. **PRESS TRNS/CONF** (call is automatically placed on hold).
3. **DIAL** extension number of telephone to receive transfer, **OR PRESS DSS/BLF** button for that extension.
4. **ANNOUNCE** call when intercom party answers.
5. **PRESS SPEAKER** to disconnect (if in station mode), **OR HANG UP**.

The intercom party then has the call (if he or she answered the screened transfer with the handset). If you announce the transfer over the speaker, the intercom party's telephone rings with the transferred call after you hang up.

#### *If the intercom party is busy or does not answer,*

1. **PRESS** flashing line button **AND LIFT** handset if privacy is desired.

## ***Unscreened Call Transfers***

You can answer a call at your station and transfer it to another telephone. If you transfer the call without first announcing it, you have made an *unscreened transfer*.

### ***To transfer an unscreened call to another system telephone,***

1. **ANSWER** call.
2. **PRESS TRNS/CONF** (call is automatically placed on hold).
3. **DIAL** extension number of telephone to receive transfer, **OR PRESS DSS/BLF** button for that extension.
4. **PRESS SPEAKER** to disconnect (if in station mode), **OR HANG UP**. The transfer will ring at the called telephone.

### ***If the intercom party is busy or does not answer,***

1. **PRESS** flashing line button **AND LIFT** handset if privacy is desired.

---

## Other Call Transferring Options

### *Hot Transfer*

A hot transfer is a type of screened transfer. This feature is useful for transferring calls to people who need to work in a handsfree mode. Once you announce the call and the system completes the transfer, the person receiving the transfer can simply begin speaking toward his or her station to answer the call.

#### *To make a hot transfer to another telephone in the system,*

1. **ANSWER** call.
2. **PRESS TRNS/CONF** (the call is automatically placed on hold).
3. **DIAL** extension number of telephone to receive the transfer **OR PRESS DSS/BLF** button for that extension.
4. **ANNOUNCE** call.
5. **PRESS TRNS/CONF**.
6. If necessary, **PRESS SPEAKER** to disconnect (if in station mode) **OR HANG UP**. The person receiving the transfer then has the call.

### *Quick Transfer*

When the quick transfer method has been programmed by the installer, it allows you to do an automatic transfer of an incoming line call without pressing the *TRNS/CONF* button.

#### *To do a quick screened transfer,*

1. **ANSWER** call.
2. **DIAL** intercom number for transfer location.
3. When party at transfer location answers, **ANNOUNCE** call.
4. **HANG UP OR PRESS SPEAKER** button.

*To do a quick unscreened transfer,*

1. **ANSWER** call.
2. **DIAL** intercom number for transfer location.
3. **HANG UP OR PRESS SPEAKER** button.

Call Transferring Summary			
Transfer option	What are the sender's actions after answering original call?	How is the transferred call delivered to the receiver?	Best suited for:
Screened Transfer	<ol style="list-style-type: none"> <li>1. Press TRNS/CONF</li> <li>2. Dial extension</li> <li>3. Announce call</li> <li>4. Disconnect</li> </ol>	Normal intercom ringing (two short bursts) and the introduction of the call; if answered in station mode, ringing will follow the transfer	Normal transfers that require introduction.
Unscreened Transfer	<ol style="list-style-type: none"> <li>1. Press TRNS/CONF</li> <li>2. Dial extension</li> <li>3. Disconnect</li> </ol>	Normal intercom ringing (two short bursts)	Expected transfers that need no introduction.
Hot Transfer	<ol style="list-style-type: none"> <li>1. Press TRNS/CONF</li> <li>2. Dial extension</li> <li>3. Announce call</li> <li>4. Press TRNS/CONF</li> <li>5. Disconnect</li> </ol>	Transfer introduction followed directly by the incoming call	Personnel who must receive speakerphone calls in a hands-free mode.
Quick Transfer (with intro)	<ol style="list-style-type: none"> <li>1. Dial extension</li> <li>2. Announce call</li> <li>3. Disconnect</li> </ol>	Intercom ringing (two short bursts) and the introduction of the call; if answered in station mode, ringing will follow the transfer	Normal transfers from attendants and operators who handle a large number of incoming calls which require transfer.
Quick Transfer (without intro)	<ol style="list-style-type: none"> <li>1. Dial extension</li> <li>2. Disconnect</li> </ol>	Normal intercom ringing (two short bursts)	Expected transfers from attendants and operators who handle a large number of incoming calls which require transfer.

## Notes

# 5

## Nonverbal Messaging

### LCD Message Delivery

You can set system-supplied messages at your station to be received and displayed by a calling LCD station.

#### *To turn on a message from your telephone,*

1. **PRESS INTERCOM AND DIAL**   .
2. **DIAL** the desired code number from your message list (01–30) on the next page,
  - For a “Back At” message, dial the code for time numbers and colon from dialing codes table.  
(For example, **DIAL**            for the time 01:45).
  - For a “Call” message, dial code for telephone number of your new location.  
(For example, **DIAL**                  for the number 978–2200).

**NOTE:** See following page for LCD dialing codes.

3. **DIAL**  **AND PRESS SPEAKER** to end message. Your intercom light flashes to indicate the waiting message.

#### *To turn off the message and your intercom light,*

1. **PRESS INTERCOM AND DIAL**   .

<b>Dialing Code Table</b>			
<b>Character</b>	<b>Dialing Code</b>	<b>Character</b>	<b>Dialing Code</b>
1	01	8	08
2	02	9	09
3	03	0	00
4	04	space	12
5	05	–	15
6	06	:	29
7	07		

<b>LCD MESSAGE LIST</b> (Write the attendant supplied messages here.)	
<b>Dial Code</b>	<b>Message</b>
01	Back at (default message 1)
02	Call (default message 2)
03	Ask them to hold (default message 3)
04	Take a message (default message 4)
05	I will call back (default message 5)
06	
07	
08	
09	



LCD MESSAGE LIST (Write the attendant supplied messages here.)	
Dial Code	Message
10	
11	
12	
13	
14	
15	
16	
17	
18	
19	
20	
21	
22	
23	
24	
25	
26	
27	
28	
29	
30	

## ***Message Waiting Light and Messaging***

If the system installer designates your station to have message-wait originate ability, you can turn on the message-waiting light of any other telephone.

### ***To turn on the message-waiting light (and a broken dial tone, if programmed) at another station that is idle or busy,***

1. **PRESS INTERCOM.**
2. **DIAL**  .
3. **DIAL** extension number **OR PRESS** DSS/BLF button of station to be alerted. The message-waiting light of called station will flash.

### ***To turn off the message waiting light at a busy or idle station,***

1. **PRESS INTERCOM.**
2. **DIAL**  .
3. **DIAL** extension number **OR PRESS** DSS/BLF button of station that was alerted. The message-waiting light of called station will turn off.

### ***To turn off the message-waiting light during message-delivering conversation,***

1. **PRESS INTERCOM** once if off-hook, twice if on-hook.

### ***To receive a message at an alerted station,***

1. **OBSERVE** flashing message waiting light or hear broken dial tone.
2. **PRESS INTERCOM AND HOLD.** The station that left the message is called automatically.

## ***Response Message Delivery***

By programming one or more RESPONSE MESSAGE buttons on your station, you can respond with a variety of messages to many calling situations. A fixed RESPONSE MESSAGE button sends the same message you previously select each time you press the button.

**NOTE:** For detailed instructions on programming a RESPONSE MESSAGE button at your station, see page 57 of the Programming chapter.

### ***To send an LCD message when you call and receive busy signal or no answer,***

1. While still on the call, **PRESS** the appropriate RESPONSE MESSAGE button to send a preselected message to the calling LCD speakerphone.

### ***To send an LCD message to a caller who has initiated a SOHVA or intercom call from another LCD telephone,***

1. **HEAR** the SOHVA tone or voice announcement in your handset or headset.
2. **PRESS** the appropriate fixed RESPONSE MESSAGE button to send a preselected message to the calling telephone.

## Notes

# 6

## Programming

### DSS Numbers

Storing another station at a DSS/BLF programmable location allows a user to monitor that station, dial with the press of one button, or pick up or hold calls at that station quickly and conveniently. You can record your station's programmed DSS and speed dial numbers on page 56 for quick reference.

#### *To store an intercom number as a DSS number,*

**NOTE:** Storing DSS numbers at button locations will overwrite any previously stored numbers.

1. **PRESS INTERCOM.**
2. **DIAL**   .
3. **PRESS** programmable button to choose DSS location.
4. **DIAL** extension number.
5. **PRESS** next location button **AND STORE** next DSS number.
6. **REPEAT** the previous step until all DSS numbers are stored.

#### **CAUTION**

**Do not attempt to program interactive buttons; doing so can cause the system to make features unavailable. If you inadvertently reprogram interactive buttons, you can retrieve the button functions in the following manner:**

1. **PRESS INTERCOM AND DIAL**
2. **PRESS** the interactive button to be reprogrammed
3. **DIAL**  ,  , or   (for buttons from left to right).



## Speed Dial Numbers

Speed dialing is a feature that lets you store and dial frequently called numbers using one or two buttons. You can store numbers for speed dialing at a keypad number or any programmable button that is **not now assigned as a line button or other feature by the system administrator or installer.**

**NOTE:** The Federal Communications Commission (FCC) requires that when programming emergency numbers and(or) making test calls to emergency numbers:

1. Remain on the line and briefly explain to the dispatcher the reason for the call;
2. Perform such activities in the off-peak hours, such as early morning or late evening.

***To store an outside number as a speed dial number, follow the display prompts and proceed as follows:***

1. **PRESS INTERCOM.**
2. **DIAL**   .
3. **PRESS** programmable button **OR** dial pad button (**0–9**) to choose storage location (remember, to access second level storage at a programmable button, press *SHIFT* first).

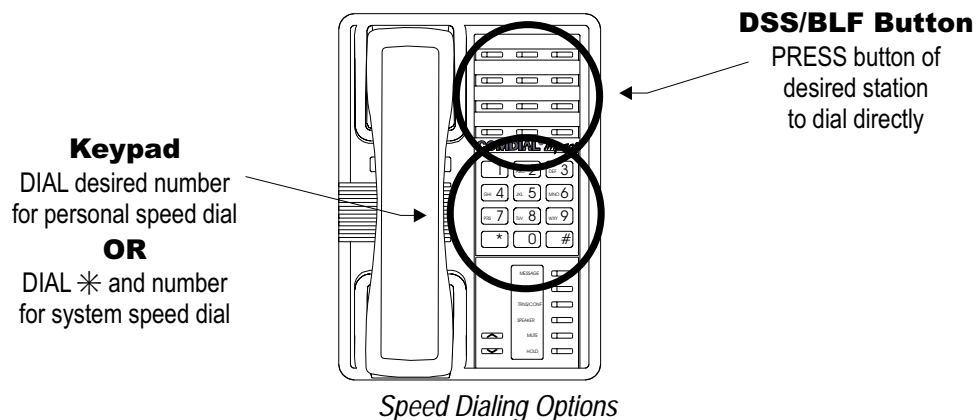

4. **CHOOSE** your speed dial route from the following list:
  - **PRESS** line button to select outside line.
  - **DIAL**  to select prime line or last line used.
  - **DIAL**  to  to select line group.
  - **PRESS** *INTERCOM* button or dial  to select intercom.

**NOTE:** You may need a pause between numbers to compensate for differences in response time between your system and the host system (ask your attendant about this). To store a pause, press **HOLD**, then continue dialing. If your system is behind a host system that needs a hookflash to access a feature, press **TAP** to store a hookflash, then continue dialing.

5. **DIAL** number (up to 16 digits long—include  and  if needed).
6. **PRESS** *TRNS/CONF* to store the number.
7. **REPEAT** previous steps until all numbers are stored.
8. **PRESS** *SPEAKER* to end.

You can record your station's programmed DSS and speed dial numbers on page 56 for quick reference.

Speed Dial Numbers, Features or DSS Locations (Programmable Buttons)			
1		13	
2		14	
3		15	
4		16	
5		17	
6		18	
7		19	
8		20	
9		21	
10		22	
11		23	
12		24	

As you program numbers, fill in the identification strips on your telephone as well as these tables.

Personal Speed Dial Numbers (Keypad Buttons)			
1		6	
2		7	
3		8	
4		9	
5		0	



## Response Message Button

You may program a RESPONSE MESSAGE button, which allows you to send an LCD message to a caller who has initiated a SOHVA or intercom call from an LCD speakerphone, or to send an LCD message to an LCD speakerphone that you call and receive a busy signal or no answer.

***To store a fixed RESPONSE MESSAGE button (delivers the same message each time it is pressed),***

1. **PRESS INTERCOM.**
2. **DIAL**   .
3. **PRESS** programmable button for RESPONSE MESSAGE button location.
4. **DIAL** message number (**01-30**) from list of messages.

<p><b>NOTE:</b> The system attendant creates the programmed messages available for use that are listed in a table on page 49.</p>
---

5. **DIAL**  to save programming.
6. **PRESS SPEAKER** to end.
7. **LABEL** button location.

## Feature Buttons

You can create feature access buttons to make operation easier. Some features that you may want to use frequently are defined as follows:

- **Account Code Button** —allows you to enter an account code for call record purposes.
- **Call Forward Button** —allows you to forward all of your calls to another telephone.
- **Camp-On With Automatic Call Back** —allows you to camp on to a station. The system calls you back as soon as the called station becomes idle or occupied.
- **Camp-On (Call Waiting)** —when calling a busy station, this feature allows you to send a call waiting tone to the station and to wait on-line for a reply.
- **Do Not Disturb Button** —prevents other telephones from ringing your telephone.
- **Group Listen Button** —allows others to hear a conversation over the telephone speaker while you use the handset or headset; the distant party can hear only the conversation transmitted through the handset or headset microphone.
- **Music Button** —allows you to enable or disable background music; also allows you to choose from two pre-programmed music sources.
- **Page Button** —provides one-button access to paging.
- **Park Button** —parks calls in preselected park orbit.
- **Pick-Up Button** —allows you to pick up a call ringing elsewhere in your system.
- **Privacy Release Button** —allows other telephones which share a line appearance for current call to join.
- **Saved Number Redial Button** —redials the last number saved
- **Voice-Announce Block Button** —blocks voice announcements.

You can store feature access codes at programmable buttons to provide yourself with one-button access to features that you use quite often. To find your feature code of interest, refer to Appendix A on page 73.

***To manually store an access code,***

1. **PRESS** *INTERCOM*.
2. **DIAL**   .
3. **PRESS** programmable button to choose storage location.
4. **DIAL** access code for feature.
5. **LABEL** button location.
6. **PRESS** next location button and store next feature code.
7. **REPEAT** previous steps until all desired feature codes are stored.
8. **PRESS** *SPEAKER* to end.

***For example, to program a button to provide group call pickup (access code #4),***

1. **PRESS** *INTERCOM*.
2. **DIAL**   .
3. **PRESS** programmable button to choose storage location.
4. **DIAL**  .
5. **LABEL** button location.
6. **PRESS** *SPEAKER* to end.

## Notes

# 7

## Other Advanced Features

### Line Groups

Some systems have telephone lines arranged into line groups that you may access for outside calling instead of selecting an individual line button.

***If your system has line groups, access them as follows:***

1. **PRESS INTERCOM.**
2. **DIAL** desired line group access code.

Line Group Access Codes		
Line Group	Default Code	Active Code*
1	9	
2 through 11	8 0 through 8 9	
12 through 16	6 0 through 6 4	

\* If your system attendant has reassigned your line group access codes, write them here for future reference.

3. **LISTEN** for outside dial tone.
4. **DIAL** desired number.
5. **LIFT** handset to talk.

## ***Automatic Redial (8124S, 8112S and 8212S only)***

If your station has the multiple automatic redial feature enabled, you can place up to 10 numbers in your telephone's redial queue.

### ***To use the automatic redial feature to redial a busy or unanswered number,***

1. While the telephone is idle, **DIAL**    **OR PRESS** the AUTOMATIC REDIAL button programmed by your installer.
2. The system repeatedly dials the number until you cancel the feature or the system has dialed the number a preprogrammed number of times (determined by your system installer).
3. The AUTOMATIC REDIAL light flashes between redials and turns on steady during redialing.
4. **IF** your installer has enabled answer supervision on your line, the system automatically cancels automatic redialing and turns the AUTOMATIC REDIAL light off.
5. **IF** answer supervision is **NOT** enabled, **PRESS** the programmed AUTOMATIC REDIAL button while on the call to cancel automatic redialing.
6. **IF** your system installer has enabled the redial multiple numbers feature, you can have up to 10 numbers in your redial queue. To add numbers to your redial queue, **REPEAT** step 1 in the above procedure.

In order to utilize the multiple automatic redial queue, you must first program a AUTOMATIC REDIAL button. The system will automatically redial only the last number placed into the queue, so you must repeatedly press the programmed button to access previous numbers in the queue. (For example, pressing the AUTOMATIC REDIAL button twice with the system idle will redial the second to last number placed into the queue.) The user must remember all numbers which have been designated for automatic redial.

### ***To scroll through numbers in your redial queue if your telephone is currently idle,***

1. **PRESS** the programmed AUTOMATIC REDIAL button repeatedly to select the desired number which has been previously placed in the redial queue.

***To interrupt the redialing procedure so that you can scroll through numbers in your redial queue,***

1. While your telephone is in the process of dialing a number, **PRESS** the programmed AUTOMATIC REDIAL button twice. This treats the number as answered, cancels automatic redialing for that number, and puts the number back in the automatic redial queue. The display shows the last number dialed.
2. The system will now dial the next number in the queue. **IF** you would like to select a different number, repeatedly **PRESS** the AUTOMATIC REDIAL button.

***To cancel the automatic redial feature, choose one of the following:***

1. **PERFORM** any user activity at the station (go on-hook, select the speaker button, etc...).
2. **DIAL**    to delete all numbers from the redial queue.
3. **SELECT** the programmed AUTOMATIC REDIAL button while the number you wish to remove from the redial queue is ringing.

## Tracker Paging System

The Tracker Paging System option allows you to send call back and parked call messages to Tracker pagers assigned to station extension numbers.

Along with the parked call message, the system parks the call in orbit for retrieval by the paged party. The type of message that the system delivers (either alphanumeric or numeric-only) is dependent upon the Tracker pager model in use at the station.

When outside callers call into a system that has both a Tracker Paging option and a voice mail option installed, the system gives these callers the option of either leaving a message or tracking the person that they are calling.

### *To track a called party after receiving a ring—no answer,*

1. **MAKE** an intercom call to someone **AND RECEIVE** no answer.
2. **PRESS INTERCOM AND DIAL**  .
3. **HEAR** confirmation beep (Tracker page accepted) **OR HEAR** busy tone (Tracker page not accepted).
4. **PRESS SPEAKER** to end.

### *To track a called party without first calling them,*

1. **PRESS INTERCOM AND DIAL**  .
2. **DIAL** extension number.
3. **HEAR** confirmation beep (Tracker page accepted) **OR HEAR** busy tone (Tracker page not accepted).
4. **PRESS SPEAKER** to end.



***To use Tracker to transfer a call to a park orbit for retrieval and transmit the call's park orbit code and caller ID information (if available),***

1. **ANSWER** call **AND PRESS** TRNS/CONF.
2. **DIAL** extension number.
3. **PRESS INTERCOM AND DIAL**  **IF** the called station does not answer or is busy.
4. **HEAR** confirmation beep (Tracker page accepted) **OR HEAR** busy tone (Tracker page not accepted).
5. **PRESS SPEAKER** button to end.

***To retrieve a call that you parked using the Tracker option,***

1. **PRESS TAP** to retrieve.

***If you receive a parked call message on your Tracker pager,***

1. **GO** to any system station.
2. **PRESS INTERCOM**.
3. **DIAL** Tracker pager orbit code (  to  ).
4. **RETRIEVE** call.

***To enable or disable a Tracker pager at your station,***

1. **PRESS INTERCOM**.
2. **DIAL**  to enable, **OR DIAL**  to disable.
3. **PRESS SPEAKER** to end.

## Volume Control

### *Setting Current Volume Level*

The volume control on your telephone is a multipurpose control you can use to set the volume (loudness) of the ringer, the speaker, the handset, the headset, background music, and the group listening mode.

***There are four ringer loudness levels (plus an off position). Set these levels as follows:***

1. While your telephone is on-hook and idle, **PRESS** the **VOLUME UP OR VOLUME DOWN** button once for each change in loudness you desire. The ringer sounds once for each change as an example of the current setting. (On the 8112N, the ringer volume is controlled by a three position switch on the bottom of the telephone.)

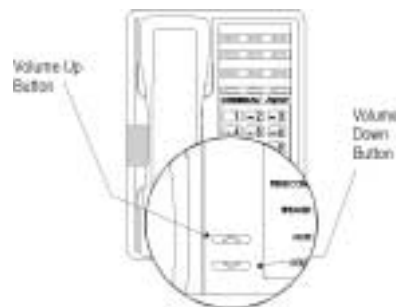

*Impact SCS Volume Buttons*

**NOTE:** If you set the ringer to the **OFF** position, your telephone will sound a short ring burst once for each call you receive at your station while the ringer is off.

***There are eight speaker loudness levels. Set these levels for the current call as follows:***

1. While on a call and in station mode, **PRESS** the **VOLUME UP OR VOLUME DOWN** button once for each change in loudness that you desire.

***There are at least eight handset loudness levels that you can set for the current call as follows (not available on 8112N):***

1. While on a call and in handset mode, **PRESS** the **VOLUME UP OR VOLUME DOWN** button once for each change in loudness that you desire.

**NOTE:** When the call ends, the system resets the loudness of all future calls to the programmed (default) setting. For instructions in setting your station's default volume, see Default Volume Control section in the system specific Advanced Features chapter.

***There are eight headset loudness levels that you can set for the current call as follows:***

1. While on a call and in headset mode, **PRESS** the **VOLUME UP OR VOLUME DOWN** button once for each change in loudness that you desire.

***There are eight group listening loudness levels. Set the level for the current call as follows:***

1. While on a call and in the group listening mode, **PRESS VOLUME UP OR VOLUME DOWN** button once for each change in loudness you desire.

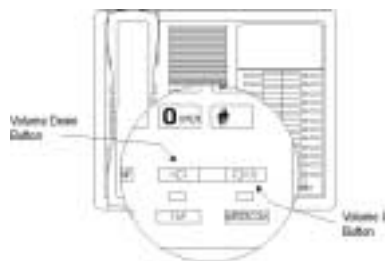

*Impact Volume Buttons*

***There are eight background music loudness levels. To set the level,***

1. While background music is on at your station, **PRESS VOLUME UP OR VOLUME DOWN** button once for each change in loudness you desire. This level will remain set for background music until you change it again, even if you turn off the feature and then reactivate it.

### ***Muting Your Station (not available on 8112N)***

By using the **MUTE** button, you can block transmission of your voice to the distant party. You can do this whether you are using the handset or the speaker.

***To mute your station,***

1. **PRESS MUTE** (mute function and light turn on). You can still hear the distant party, but he or she cannot hear you.

***To speak to the distant party,***

1. **PRESS MUTE** again (mute function and light turn off).

## Default Volume Control

You can set a permanent loudness level for any volume control setting. The level will remain at this volume (referred to as the default setting) until you change the setting.

**To set a permanent speaker, headset, handset, or group listening loudness for all future calls,**

1. **PRESS INTERCOM.**
2. **ACTIVATE** speaker, headset, handset, or group listen mode to be affected.
3. While in that mode, **PRESS VOLUME UP** or **VOLUME DOWN** button to adjust loudness.
4. **DIAL**    **OR PRESS** programmed **SAVE** button to hold the loudness at the last setting for all future calls (until you change the default again).
5. **REPEAT** this procedure in each mode until you've set all default volume levels.

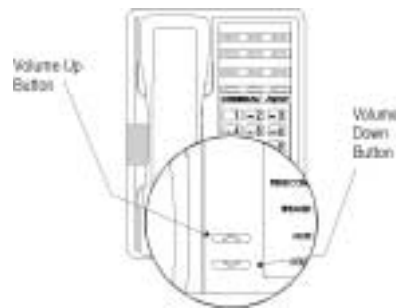

*Impact SCS Volume Buttons*

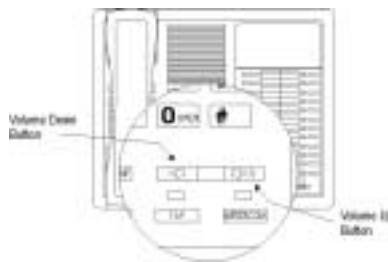

*Impact Volume Buttons*

## ***Background Music*** ***(not available on 8112N or 8212N)***

If the telephone system supplies background music, you can turn it on at your station while it is on-hook and idle. The system automatically turns background music off during calls and voice announcements.

### ***To turn the music on,***

1. **PRESS INTERCOM.**
2. **DIAL**  for music source one **OR**  for music source two if available (the **SPEAKER** light turns on when background music is on).
3. **ADJUST** music volume with the volume button.

**NOTE:** The system may provide music from two sources; however, this feature must be enabled by the system installer.

### ***To turn the music off,***

1. **PRESS INTERCOM.**
2. **DIAL** , (the **SPEAKER** light turns off when background music is off).

## **Automatic Set Relocation**

If your installer has equipped your system with automatic set relocation, when you move your telephone to a new location, the system gives you a choice (through a display prompt) as to whether you want to keep your previous programming or use the programming in the new location.

### ***To maintain the extension number and programming features from the old location,***

1. **CONNECT** the telephone line cord to the new jack.
2. **OBSERVE** the flashing HOLD light **AND PRESS HOLD** while the light is still flashing (your telephone immediately assumed the features from the previous location).

**NOTE:** If you do not select a button after installing the telephone, the system automatically defaults to the programming from the previous location.

### ***To assume the extension number and programming features from the new location,***

1. **CONNECT** the telephone line cord to the new jack.
2. **OBSERVE** the flashing HOLD light **AND DIAL**  while the light is still flashing (your telephone immediately assumes the features from the new location).

## DSS/BLF Console Operation

The IB64X, IB48X, and IB24X *DSS/BLF* consoles have additional buttons and status lights that extend the memory button capability of an adjacent companion telephone. The buttons can be programmed for automatic dialing (speed dial) or direct station selection (DSS) with busy lamp field (BLF) using the instructions provided previously in this guide.

When the installer assigns a *DSS/BLF* console to a station port, the system recognizes it as such and automatically clears (blanks) the console buttons so that you can store numbers at the buttons as you need them.

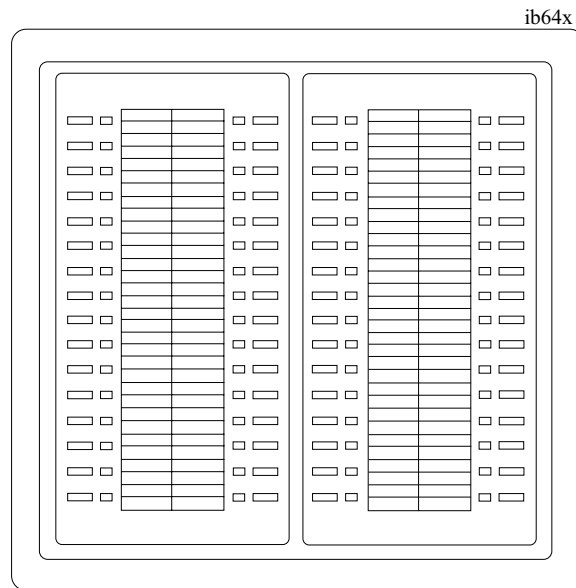

IB64X *DSS/BLF* Console

## Accessing The DSS/BLF Console Button Levels

The IB24X and IB48X DSS/BLF consoles have four levels of buttons, quadrupling the consoles' button capacity. The four buttons at the bottom of each console allow you to select which button level is currently active. To change button levels, press one of the buttons at the bottom of the console. The leftmost button activates level 1, the next button activates level 2, etc. A light beside the appropriate button lights to indicate which level is currently active.

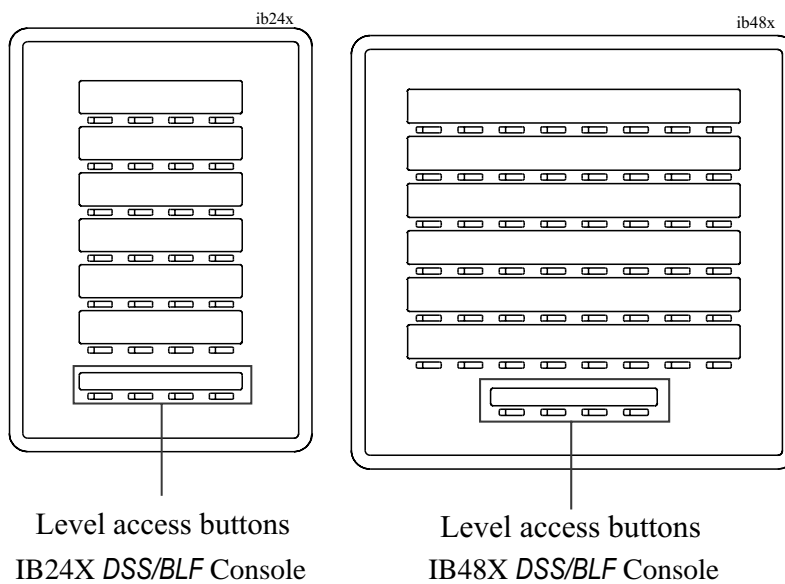



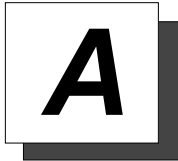

## Feature Access Codes

This chart provides you with a Quick Reference Guide of the feature dialing codes. If you wish, you can detach these pages and keep them near your telephone to serve as a stand alone reference. Chapter 8, *Programming Your Telephone*, describes a method to program these codes on your telephone at unused programmable buttons.

Feature	Enable Code	Disable Code
Account Code	INTERCOM + * 0 4 + account code	
All Call	INTERCOM + 7 0	
Attendant Calling	INTERCOM + 0	
Authorization Code	INTERCOM + # 0 8 + authorization code	
Automatic Callback and Call Waiting	INTERCOM + * 6	INTERCOM + # 6
Background Music	INTERCOM + 1 1 or 1 2	INTERCOM + # 1
Call Divert Station	INTERCOM + * 5 5 + extension number	
Call Forward, Personal	INTERCOM + * 5 1 + extension number	INTERCOM + # 5

Feature	Enable Code	Disable Code
Call Forward, Ring-No Answer, All Calls	INTERCOM + *54 + extension number	INTERCOM + #5
Call Forward, Ring-No Answer, Personal Calls	INTERCOM + *53 + extension number	INTERCOM + #5
Call Forward, All Calls	INTERCOM + *52 + extension number	INTERCOM + #5
Call Park, Orbit 910-990	INTERCOM + * + 910 to 999	
Call Park, Pickup	INTERCOM + # + 910 to 999	
Call Pickup, Directed	INTERCOM + *4 + extension number	
Call Pickup, Group	INTERCOM + #4	
Clear Major Alarm Ring	INTERCOM + #09	
DISA Access	Installer Assigned	
Do Not Disturb	INTERCOM + #01	INTERCOM + #01 (repeat)
Do Not Disturb Override	extension number + *03	
DSS Programming	INTERCOM + **3	
Executive Override	extension number + *03	
Hold, Manual	HOLD	

Feature	Enable Code	Disable Code
Hold, Exclusive	HOLD + HOLD	
Hold, Directed	INTERCOM + *90	
Hold, Directed Pickup	INTERCOM + #90	
LCD Messaging	INTERCOM + *02 + message	INTERCOM + #02
Line Group 1	INTERCOM + 9	
Line Groups 2-11	INTERCOM + 80 to 89	
Line Groups 12-16	INTERCOM + 60 to 64	
Line Pick Up From Any Station, Zones 1-4	INTERCOM + 65 to 68	
Line Pick Up From Any Station, All Zones	INTERCOM + 69	
Meet-Me Answer Page	INTERCOM + 78	
Message Waiting	INTERCOM + *3 + extension number	INTERCOM + #3 + extension number
Message Wait Retrieval	#00	
Operator Access	INTERCOM + 0	
Paging, All Call	INTERCOM + 70	
Paging, Zones 2-8	INTERCOM + 71 to 77	

Feature	Enable Code	Disable Code
Paging, Meet-Me	INTERCOM + <b>78</b>	
Park Orbit Retrieve	INTERCOM + <b>#</b> + <b>910</b> to <b>999</b>	
Park Orbit Send	INTERCOM + <b>*</b> + <b>910</b> to <b>999</b>	
Personal Ringing Tones	INTERCOM + <b>**4</b> + tone code ( <b>1</b> to <b>8</b> )	
Redial Last Dialed Number	<b>#</b>	
Remote Station Disable	INTERCOM + <b>*05</b> + extension number	INTERCOM + <b>#05</b> + extension number
Response Message	INTERCOM + <b>**6</b> + button + <b>01</b> to <b>30</b>	
Service Observing	INTERCOM + <b>#03</b> + extension number	
Speed Dial, Station	Keypad <b>1</b> , <b>2</b> , <b>3</b> , <b>4</b> , <b>5</b> , <b>6</b> , <b>7</b> , <b>8</b> , <b>9</b> , or <b>0</b> .	
Speed Dial, System	<b>*100</b> to <b>*599</b>	
Speed Dial, Programming	INTERCOM + <b>**1</b>	
Station Lock	INTERCOM + <b>#04</b> + code	

Feature	Enable Code	Disable Code
Volume Save	INTERCOM + * * 7	
Voice-Announce Block	INTERCOM + * 2	INTERCOM + # 2

**NOTE:** The dialing codes provided in this quick reference guide are default values. Your system installer has the ability to renumber these codes.

The following table details several unique dialing codes that are only applicable to single line proprietary and industry-standard telephones.

Feature	Enable Code
Pick Up Last Line	* 0 8
Broker's Call	* 0 7
Speed Dial Access Code	* 0 1
Saved Number Redial	* 0 6
Dial Saved Number	* 0 9
TAP Dialing Code	# #

## **Notes**

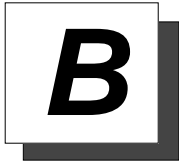

## Glossary

### A

**Account Code**

A group of numbers, up to 16 digits in length, entered by station users during incoming or outgoing calls; the system uses account codes to identify the calls by category, or special grouping, for call accounting purposes.

**All-Call Paging**

Paging through the intercoms of all stations in the system.

**Assist Button**

A button that you can program that will let you send a message requesting assistance to the LCD of another telephone.

**Attendant**

Also known as the operator; typically, the first person to answer incoming calls and responsible for directing calls to the proper person or department.

**Automatic Callback**

System will ring a calling telephone when a busy called telephone becomes idle.

**Automatic Dialing (or Autodialing)**

Using programmable buttons to store numbers for one- or two-button dialing.

**Automatic Redialing**

Turning on a program that automatically redials the last number dialed once a minute for 10 minutes.

**Automatic Route Selection (ARS)**

ARS allows the system to automatically select the least costly line group available to a station to route a call. The system modifies the dialed number, if needed, to match the selected line group. ARS makes routing decisions (which lines to route a call over, if and how to modify a number, and costing information) based entirely upon the programming of the system.

**Automatic Station Relocation**

Process by which the system automatically recognizes particular stations if they are relocated to a different station port; the same class of service and station features are provided the station at the new port.

**B****Block Programming**

To eliminate the need to program each station individually, programmers can assign features or functions to groups of stations.

**Button Query**

Feature which allows users to display the functions of programmable buttons on LCD telephones.

**C****Call Forward**

Designating another telephone to receive intercom calls normally directed to the user's telephone.

**Call Forward Outside System (CFOS)**

Allows station users to forward incoming or transferred line calls to telephone numbers outside the system.

**Call Park**

Placing an active call at a particular telephone in system hold (park orbit) and retrieving it by any telephone.

**Call Pick-Up**

Answering a call at one telephone when it is ringing at another telephone.

**Call Transfer**

Transferring a call from one station to another. The transfer can be screened, i.e., you find out who is calling and announce them to the party being called; or unscreened, i.e., you transfer the call without identifying the calling party to the called party.

**Caller ID**

Allows station users to view the originating line number of incoming calls before they are answered.

**Camp On**

Process that allows a user to wait for a busy or idle line to become available and immediately be called back by the system; also allows users to send a tone to busy telephone to notify the station that a call is waiting.

**Central Message Desk**

A station that has been assigned to control message waiting lights and deliver messages to other stations in the system.

**Class Of Service (COS) Programming**

Customized programming of your system by the installer that establishes the basic operating parameters of the system and individual stations.



**D****Data Interface Unit (DIU)**

This optional unit provides connections for your standard multiline digital telephone and Industry Standard Telephone (IST) device such as a FAX machine or answering machine.

**Departmental Station Operation**

The operation of stations that are organized into departments.

**Dial By Name**

This feature allows users to employ any two-line display, LCD speakerphone and its interactive buttons to search through an index of names, locate a desired station name or system speed dial name, and automatically call the located item.

**Digital Voice Announcing (DVA)**

The DVA is a line-powered device that provides voice prompts for auto-attendant and transfer, or you can use it to enhance the operation of DISA and Tracker.

**Direct Inward System Access (DISA)**

An enhancement option that allows outside callers to directly call a station or access certain internal system features, including all line groups and ARS. To prevent fraudulent access and unauthorized use, the caller must use an authorization code and system access code to gain access to outside lines as well as many of the advanced telephone features.

**Direct Inward Station Dialing (DISD or DID)**

This feature allows an outside party to call an intercom station directly without an attendant's assistance.

**Direct Station Selection/Busy Lamp Field (DSS/BLF)**

Programmable buttons which allow the user one button to place intercom calls to other stations within your system; the button is sometimes referred to as a DSS button. Busy lamp field or BLF is a term for a light that identifies current call status of DSS station. See telephone layout drawings in Chapter 1 for location.

**Do Not Disturb**

A mode that disables incoming call ringing and intercom calling.

**Dual Tone Multiple Frequency (DTMF)**

The tones made by your telephone when you dial.

**DXP, DXP Plus, FXS and FXT**

Common Code Based Systems; DXP, DXP Plus, FXS and FXT Comdial Communication Systems so named because the programmed function codes of these systems are interchangeable.

**Dynamic Line Button**

System temporarily assigns a normally unassigned line to an idle line button for certain call handling operations.

**E****E&M Tie Lines**

In telephony, a separate pair of leads to your station which are used by system operators for signaling and supervisory purposes.

**Exclusive Hold**

Only the telephone placing the call on hold can retrieve it.

**Executive Override** Breaking into a conversation at a busy called telephone. This intrusion is announced by several quick tone bursts over the conversation.

**H****Handsfree Answer Inhibit**

A telephone can be set to block voice calls sent to it over the speaker.

**Hookflash**

Action that occurs when the TAP button is pressed. Needed for activating host system features.

**Hookswitch**

The switch on a telephone which, when depressed manually or by the handset, disconnects a call.

**I****IMIST**

Module which allows the connection of an external device to a Comdial digital telephone.

**Industry Standard Telephone (IST)**

Analog telephone with only a basic 12 button keypad and no advanced features

**Intercom**

An internal communication system that allows you to dial another station at your office or location without connecting to the outside telephone system.

**K****Keypad**

Buttons  through ,  and  used for dialing.

---

**L****Last Number Redialing**

Automatically dialing the last number dialed.

**LCD**

Liquid crystal display; the alphanumeric display of several Comdial Digital Telephone models.

**Line Groups**

Programmers assemble and program outside lines into distinct line groups which users must dial a certain code to access.

**Line Queuing**

When several telephones share a line and that line is busy, a user can dial a code and hang up to wait for the line to become idle. When the line becomes idle, the user's telephone will ring.

---

**M****Meet-Me Answer Page**

Any user can dial a code in response to an all-call or zone page and be connected to the paging party in a private conversation.

**Messaging**

Turning on a telephone lamp to let the user know that a message awaits pickup and leaving a message on the display of a telephone that gives information on your status.

**Mute**

A fixed feature button that keeps a distant party from hearing your conversation. This button also lets you adjust the telephone display contrast from light to dark.

---

**N****Night Transfer**

Transferring incoming calls to a particular station(s) for off-hour answering.

---

**O****Operator Station**

Also known as the attendant station, this system station is programmed to ring when users dial the operator; usually considered the central message desk of the system although multiple attendant stations are possible

**P****Paging**

This feature allows station users to dial-up customer provided loudspeaker paging equipment and page over externally placed loudspeakers and determines what paging zones, if any, a station can page over.

**Prime Line**

A line designated to a particular telephone and automatically selected when the handset is lifted.

**Privacy**

Line feature, assigned by the programmer, to allow only one station to access a line at any time; no other station has access to the line unless the user makes it available through conferencing.

**Programmable Buttons** Each telephone or station has buttons that can be user-programmed for autodialing numbers or feature codes, or other special purpose dialing requirements.

**Pulse/Tone Switching**

Changing from pulse/rotary dial signals to tone/DTMF signals.

**Q****Queue**

Method by which a station user waits for an available line by dialing a code and waiting for the system to call back.

**R****Response Messaging**

Responding non-verbally to a calling station by pressing a programmed button that sends a message to the calling station's display.

**Ring Line Preference**

An automatic connection to any outside line ringing at the station when the station handset is taken off-hook.

**Ring Tones, Personal**

A telephone can be arranged to ring in one of six distinctive tones.

**S****Saved Number Redialing**

Saving a last manually dialed number for later autodialing.

**Screened Call Transfer**

Allows users to first announce and then transfer both line and intercom calls from one station or group to another.

**Service Observing**

Class of service programming option allows users to enter an in-progress call in an unannounced muted mode to monitor the call.

**Speed Dialing**

Autodialing using the keypad buttons. Speed dialing can be station calls (personal and accessed by only one specific user) or system calls (numbers used and accessed by anyone in the system).

**Station**

A single system telephone with an individual identity and feature set assigned by the programmer.

**Station Message Detail Accounting (SMDA)**

Station message detail accounting provides a record of the incoming and outgoing calls handled by the system on selected lines. This record provides information for accounting and traffic analysis studies.

**Subdued Off-Hook Voice Announce (SOHVA)**

A private announcement that can be made to a busy party which they hear through the receiver of their handset.

**System Alarm Reporting**

Allows you to view (through the LCD telephone screen) the various system alarms and the stations with which those alarms are associated.

**System Speed Dial**

System speed dialing provides system users with a repertory of up to 500 numbers that they can dial from any telephone in the system. The installer or the attendant is responsible for storing the system speed dial numbers.

**T****TAP (Flash/Recall)**

Depending on your system's programming, this button gives you a fresh dial tone or activates a hookflash.

**Toll Restriction**

Class of service feature by which the system allows or denies outgoing calls to selected users over selected lines.

**Tone Call**

A ringing intercom call.

**Tracker Pager**

The Tracker optional pager system allows you to send and receive messages to Tracker pagers assigned to station extension numbers.

**TRNS/CONF**

A fixed feature button that allows you to transfer outside calls and set up conference calls.

**U****Unscreened Call Transfer**

Allows users to transfer line or intercom calls from one station or group to another without first announcing them.

**Unsupervised Conference**

After establishing a conference between two outside parties, the originator drops out leaving a line to line unsupervised connection with the remaining parties.

**V****Voice call**

A verbal intercom call.

**Voice Announce Blocking (VAB)**

A telephone can be set to block voice calls sent to it over the speaker.

**Z****Zone Paging**

Paging through the intercoms of some stations or departments in the system.

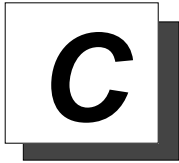

## ***Speakerphone Characteristics***

When using your speakerphone, the microphone and loudspeaker are farther away from you than when you use a handset. Both the signal from the loudspeaker and the signal to the microphone must be enhanced.

When microphones and loudspeakers are close together (such as in a speakerphone), additional amplification typically generates a ringing sound (public address systems do this if the volume is too high or the microphone is too close to a loudspeaker).

### ***Speakerphone User Guidelines***

- Both parties can not talk at the same time. You must wait for silence out of your loudspeaker before talking. You must stop talking to hear the other party.
- Background noise may prevent the sound-activated switches from operating properly. Avoid placing the speakerphone where it will detect sounds from typewriters, keyboards, printers, paging systems, and other equipment.
- Speak slightly louder than normal and with a clear, authoritative voice. For the microphone to best detect your voice, speak within three feet of it and face the telephone.
- Raising the volume of the loudspeaker makes it easier for the sound-activated switches in your telephone to select the distant party's voice. Lowering the volume of the loudspeaker makes it easier for the switches to select your voice.
- Since the system takes several seconds to provide the best switching, constant sound patterns—such as elongating your words and playing externally-supplied music—may prevent the sound-activated switches from operating properly.

- Place the telephone on a hard surface and away from table edges. Do not place the telephone in corners or enclosures. Do not let obstructions come between you and the microphone. Rooms with hard, flat surfaces that reflect sound may affect the sound-activated switches.
- If you are using a handset and the other party is using a speakerphone, avoid breathing heavily into your microphone. Avoid other sounds that may affect the distant telephone's sound-activated switches.
- In some situations, such as when either you or the distant party are in a noisy environment, you may have to lift your handset to ensure a clear conversation.
- When both you and the distant party use speakerphones, the sound-activated switches can occasionally detect both voices simultaneously, thus blocking out both voices.





## Feature Networking Support

The table below shows all the features available on Set 15A. It identifies whether each feature is for a local stand-alone system or a system-to-system network. System-to-system networking connects several DXP, DXP Plus, FXS and FXT systems together in an arrangement that allows unified communications through the system. Also provided is information on which features Comdial provides remote networking support too.

Feature Name	Type Originating/Terminating/Both	Remote Networking Support	Feature Parameters	Program Feature
Abandoned Hold Release	Terminating	None	Across Network	
Account Code	Both	None	Across Network	Node/COS
Alarms			Local	Node
A-lead			Local	Node
Alternate Attendant	Terminating	Comdial	Local	Node
ANI (passed across the network but must be enabled per node)	Terminating	Comdial/QSIG	Local (display telephones)	Node
ANI DNIS (passed across the network but must be enabled per node)	Originating	Comdial/QSIG	Local (display telephones)	Node
ANS Detect	Originating	Comdial	Across Network	
ARS	Both	Comdial	Across Network	Node
	N/A	None	Local	Node
Attendant Programing	Both	Comdial	Local	Node
Authorization Code	Originating	None	Local	Node
Auto Hold	Terminating	None	Across Network	Node
Auto Pause	Terminating	None	Across Network	Node

<b>Feature Name</b>	<b>Type Originating/ Terminating/Both</b>	<b>Remote Networking Support</b>	<b>Feature Parameters</b>	<b>Program Feature</b>
Auto Redial	Originating	None	Across Network	Node
Aux Line			Across Network	Node
Aux Ring			Local	Node
Block Program			Across Network	Incoming DID Node
Button, Programmable	Both	Comdial	Across Network (with limitations)	Node/Station
Call Costing	Originating	None	Across Network (with limitations)	Node/Station
Call Divert	Terminating	Comdial	Local	Node/Station
Call Forward Default Forward	Terminating	Comdial	Across Network	Node/Station
Call Forward All Immediate	Terminating	Comdial	Across Network	Node/Station
Call Forward All RNA	Terminating	Comdial	Across Network	Node/Station
Call Pickup Directed	Terminating	Comdial	Across Network	Node/Station
Call Pickup Group	Terminating	None	Local	Node/Station
Call Time	Originating	None	Across Network	Node/Station
Call Transfer	Both	Comdial	Across Network	Node/Station
Call Waiting Tone	Terminating	None	Local	Node/Station
Camp On	Terminating	None	Local	Node/Station
CFOS	Both	None	Local	Node/Station
Clock Set			Local	Node
Conference	Both	Comdial/QSIG	Across Network (with limitations)	Station
COS			Local	Node
Day Night Class of Service	Both	Comdial	Local	Node
Delay Hot Line	Terminating	None	Local	Node/Station

Feature Name	Type Originating/ Terminating/Both	Remote Networking Support	Feature Parameters	Program Feature
Dist Ring	Terminating	None	Local	Node/Station
Dial by Name	Originating	None	Local	Node/Station
Directed Station Hold	Both	None	Local	Node/Station
Disable Station			Local	Node/Station
Disconnect Notification	Both	None	Across Network	
DND/inhibit/override	Terminating	Comdial/QSIG	Local	Node
DNIS (passed across the Network but must be enabled per node)	Both	Comdial	Local (display phones)	Node
DSS/BLF	Both	Comdial	Across Network (with limitations)	Node/Station
DTMF Signaling	Both	None	Across Network	
Enhanced Night Mode	Terminating	None	Across Network	Node
Enhanced Ringing	Terminating	None	Across Network	Node
Executive Override	Both	None		
Extended DTMF				
Feature Numbering			Local	Node
Group Listen	Terminating	None	Across Network	Node/Station
Hands Free	Both	None	Across Network	Node/Station
Hold	Terminating	Comdial/QSIG	Across Network	Node/Station
Hunt Group (can access Hunt group across Network but members must be local to each other)	Terminating	Comdial	Across Network	Node
Hunt List	Terminating	None	Local	Node/Station
Idle Line	Both	None	Local	Node
Incoming Call Routing	Both	Comdial	Across Network	Node
Intercom Numbering			Local	Node

<b>Feature Name</b>	<b>Type Originating/ Terminating/Both</b>	<b>Remote Networking Support</b>	<b>Feature Parameters</b>	<b>Program Feature</b>
Intercom Speed Dial Last Number Dialed	Originating	None	Across Network	Node/Station
LCD Contrast	Both	None	Local Station Only	Node/Station
LCD Messaging	Both	None	Local	Node
Line Group	Both	None	Local or Network Channels	Node
Line Monitoring	Both	Comdial	Local	Node
Line Names	Both	Comdial/QSIG	Across Network	Node
Line Queue	Both	None		
Lock	Both	None	Local	Node/Station
Location Codes	Both	None	Local	Node
Mark	Both	None	Local	Node/Station
Message Deposit	Both	Comdial	Local	Node/Station
Message Waiting	Terminating	Comdial	Across Network	Node/Station
Music, Background	Both	None	Local	
Music, On Hold	Both	None	Local	
Mute	Both	None	Across Network	Node/Station
Operator/Network	Both	Comdial	Across Network	Hub
Operator/Node	Both	Comdial	Local	Node
Page	Both	None	Local	Node
Park Orbit	Terminating	None	Local	Node
Personal Ring Tone	Terminating	None	Local Station Only	Node/Station
Prime Line	Originating	None	Local	Node/Station
Privacy	Terminating	None	Local	Node/Station
Pulse Set On	Originating	None	Local	Node
Query (button)	Originating	None	Local	Node/Station
Queue	Terminating	Comdial	Local	Node/Station

Feature Name	Type Originating/ Terminating/Both	Remote Networking Support	Feature Parameters	Program Feature
Quick Transfer	Terminating	Comdial	Across Network (with limitations)	Node/COS
Recall Call Forward			Across Network (with limitations)	Node/Station
Recall Timing (Hunt Group)	Terminating	Comdial/QSIG	Across Network	Node
Record	Both	Comdial	Across Network	Node/Station
Response Message	Both	None	Local	
Ring Monitoring	Terminating	Comdial	Local	Node/Station
Serial Transfer	Terminating	Comdial/QSIG	Local	
Service Observe	Originating	None	Local	Node/Station
Shift for Speed Dials	Both	None	Across Network	Node/Station
Silent for Ringing	Both	None	Local	Node/Station
SLPS—Brokers Mode	Both	None	Local	
SLPS—Dial Saved Number	Originating	None	Across Network	
SLPS—Pick Up Last Line	Terminating	None	Across Network	
SLPS—Save Number	Originating	None	Across Network	
SLPS—TAP	Both	None	Across Network	
SMDA/SMDR	Both	Comdial	Across Network (with limitations)	Node
Softkey	Both	Comdial	Across Network (with limitations)	
SOHVA	Terminating	Comdial	Local	Node/Station
SOHVA Service Observe	Originating	None	Local	Node/Station
Dial	Originating	None	Across Network	Node/Station

<b>Feature Name</b>	<b>Type Originating/ Terminating/Both</b>	<b>Remote Networking Support</b>	<b>Feature Parameters</b>	<b>Program Feature</b>
System Speed Dial	Both	None	Across Network	Node
Station Monitoring (DSS/BLF)	Both	Comdial	Across Network (with limitations)	Hub only
Station Names	Both	None	Across Network	Node/Station
Station State Query	Originating	Comdial	Across Network	Node/Station
Subdue Ringing	Terminating	Comdial	Local	Node/Station
System Manager Prog	Both	None	Local	
System Parameters	Both	None	Local	Node
TAFAS (line answer from any station)	Both	None	Local	Node/Station
Toll Restriction	Both	None	Across Network	Node/COS
Tracker	Both	Comdial	Local	
Transfer to Voice Mail	Both	Comdial	Across Network	Node/Station
Trunk to Trunk Transfer	Both	Comdial	Across Network	
Voice Announce Block	Terminating	Comdial	Across Network	Node/Station
Serial WP Integration			Across Network	Hub and VM
VVP			Across Network	Hub and VM

# Index

## A

- Answering Calls
  - intercom calls, 14
  - outside calls, 13
- Automatic Dialing, 25
- Automatic Set Relocation, 70

## B

- Busy Lamp Field (BLF) Light
  - location, 6, 7, 9, 11
- Button Locations, 6, 7, 9, 11

## C

- Call Forwarding
  - See** Forwarding Calls
- Call Parking
  - See** Parking Calls
- Call Pick-Up
  - answering for any station (directed), 18
  - answering within a group, 18
- Calling
  - automatic dialing, 25
  - dialing intercom numbers (tone-first), 24
  - dialing intercom numbers (voice-first), 24
  - dialing outside numbers, 23
- Camping On
  - waiting for a busy station, 29
  - waiting for a DND station, 29

## CFOS

- See** Call Forward Outside System

## D

- Dialing
  - See** Calling
- Direct Station Select (DSS) Button
  - associated lights, 10
  - functions, 8
  - location, 6, 7, 9, 11
- Do Not Disturb
  - enabling/disabling operation, 22
  - function, 22
- DSS/BLF Console Button Levels, 72
- DSS/BLF Console Operation, 71
- Dynamic Save Button, 27

## E

- Exclusive Hold, 16

## F

- Flash Button
  - See** TAP Button

## G

- Group Listening
  - setting the volume, 67

## H

- Handset, setting volume, 66
- Headset
  - setting the volume, 67
- Hold Button
  - functions, 8
  - location, 6, 7, 9, 11
  - meaning of associated light, 11
- Holding Calls
  - basic instructions, 16
  - using exclusive hold, 16

## I

- Intercom Button
  - functions, 8
  - location, 6, 7, 9, 11
  - meaning of associated light, 11

## L

- Last Number Redial, 26
- Lights, Display, 10

## M

- Making Calls
  - See** Calling
- Message Button
  - location, 6, 7, 9, 11

- Message Waiting Light
  - basic function, 6
- Music
  - selecting, 69
  - setting the volume, 67
- Mute, 67
- Mute Button
  - location, 6, 7, 9, 11
  - meaning of associated light, 10

## R

- Redialing
  - last number dialed, 26
  - See Also** Saved Number Redial
  - storing numbers for future redial, 26
- Response Messaging
  - responding to SOHVA using, 20
- Ringer
  - selecting a personal tone, 3
  - setting the volume, 66
  - turning off, 3, 66

## S

- Shift Button
  - functions, 8
  - location, 6, 7, 9, 11
- Speaker Button
  - function, 8
  - location, 6, 7, 9, 11
  - meaning of associated light, 11
- Speakerphone
  - button functions, 6, 8
  - General diagram, 6, 7, 9, 11
  - setting the volume, 66
  - user guidelines, 87



Subdued Off-Hook Voice Announcement (SOHVA)

- blocking all SOHVAs, 20
  - making a SOHVA, 32
  - responding nonverbally, 20
- See Also** Response Messaging

Transferring Calls

- screened transfers, 42
- unscreened transfers, 43

TRNS/CNF

**See** Transfer/Conference Button

**T**

TAP Button

- function, 9
- location, 6, 7, 9, 11

Transfer/Conference Button

- function, 9
- location, 6, 7, 9, 11

**V**

Volume Control

- initial settings, 66

VOLUME DOWN Button

- function, 66

VOLUME UP Button

- function, 66

*Notes*

This manual has been developed by Comdial Corporation (the "Company") and is intended for the use of its customers and service personnel. The information in this manual is subject to change without notice. While every effort has been made to eliminate errors, the Company disclaims liability for any difficulties arising from the interpretation of the information contained herein.

The information contained herein does not purport to cover all details or variations in equipment or to provide for every possible contingency to be met in connection with installation, operation, or maintenance. Should further information be desired, or should particular problems arise which are not covered sufficiently for the purchaser's purposes, contact Comdial, Inside Sales Department, P.O. Box 7266, Charlottesville, Virginia 22906.

Comdial® strives to design the features in our communications systems to be fully interactive with one another. However, this is not always possible, as the combinations of accessories and features are too varied and extensive to insure total feature compatibility. Accordingly, some features identified in this publication will not operate if some other feature is activated.

Comdial® disclaims all liability relating to feature non-compatibility or associated in any way with problems which may be encountered by incompatible features. Notwithstanding anything contained in this publication to the contrary, Comdial makes no representation herein as to the compatibility of features.

GCA70-313.07 05/00  
Printed in U.S.A.

Printed in U.S.A.  
MKTBUSG Rev. 1

**COMDIAL**  
**The Rising Star**

Comdial Corporation  
1180 Seminole Trail  
Charlottesville, VA  
22901-2829  
1-800-COMDIAL  
[www.comdial.com](http://www.comdial.com)